

XR100/XR500 USER GUIDE

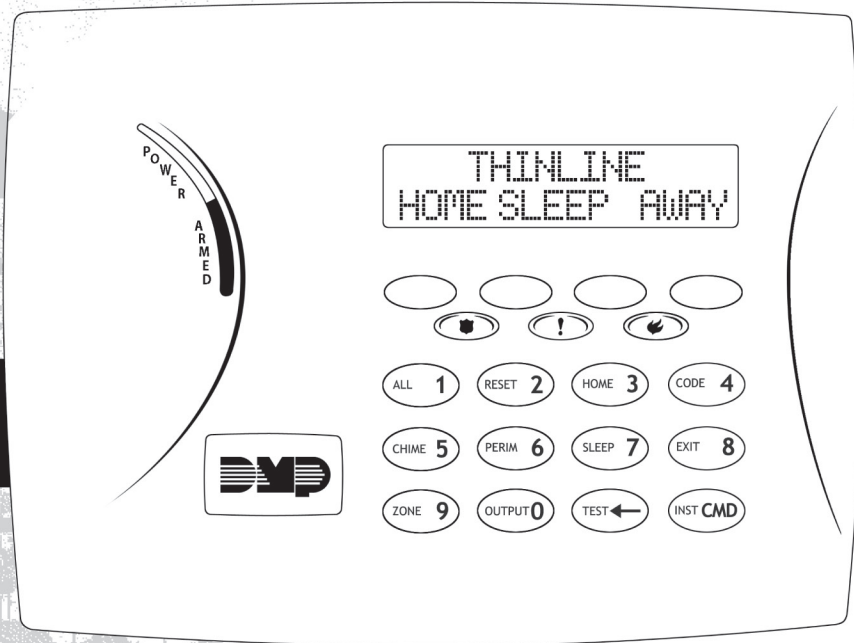

Silencing an Alarm

When the alarm bell or siren is sounding, enter your user code or present your card to a keypad or reader during the Status List display.

All/Perimeter, Home/Sleep/Away, or Home/Sleep/Away with Guest System

CANCEL VERIFY displays.

- If a burglar alarm is valid, press VERIFY to send a verification message to the Central Station.
- If a valid alarm has not occurred, press CANCEL to cancel the alarm and send an Abort or Cancel message to the Central Station and the security system will be disarmed.

© 2012 Digital Monitoring Products, Inc.

Information furnished by DMP is believed to be accurate and reliable.

This information is subject to change without notice.

Security Command User's Guide for XR500/XR100 Series Command Processor™ Panels Table of Contents

<i>Section</i>	<i>Page</i>	<i>Section</i>	<i>Page</i>
XR500 and XR100 Security Command™ Systems	1	7/0 Panic Function	5
About Your Security System	1	Thinline™ and Aqualite™ Keypads:	5
Parts of the System	1	Common Keys on All Keypads.....	5
LCD Keypad.....	1	Using the Keypad	6
Keypad User Menu	1	Multi-lingual Display Option	6
A Note About False Alarms	1	Keypad Displays Current Programming	6
Test Your System Weekly.....	1	Multiple Displays (XR500 System Only).....	6
Emergency Evacuation Plans	2	Asterisks in Area Armed Displays.....	6
Draw a Floor Plan of Your Home or Business.....	2	Keypad User Options	7
Develop Escape Routes	2	Backlighting Brightness	7
Decide Where to Meet.....	2	Internal Speaker Tone	7
Practice Your Escape Plans	2	Volume level.....	7
Early Detection	2	Model Number	7
DMP Keypads	3	Serial Number.....	7
The Select keys.....	4	Keypad Address.....	7
Thinline™, Aqualite™ and Wireless Keypads:	4	Special Keypad Tones	7
Clear Touch™ Keypads:	4	What to do when the trouble tone sounds	8
Power/Armed LED	4	DMP Wireless	8
Thinline™ and Aqualite™ Keypads:	4	Special Wireless Displays	9
Clear Touch™ Keypads:	4	Special Keypad Displays.....	9
Power/Armed Logo.....	4	Email/Cell Phone Messages	10
Thinline™ Wireless Keypads:	4	In Touch™ Text Messaging Commands	10
Panic Functions	5	Understanding Security System Terms	10
Thinline™, Aqualite™ and Wireless Keypads:	5		
Clear Touch™ Keypads:	5		

Arming and Disarming	13
General Arming Operation.....	13
Arming Functions.....	13
Key Fob Arming.....	14
Key Fob Disarming	15
Area System Arming Operation	15
Arming the Area System.....	15
Quick Arming.....	16
Checking the Armed Areas.....	16
Area System Disarming Operation	16
Disarming the Area System from the keypad.....	17
Quick Disarming	17
All/Perimeter System Arming.....	17
System Ready/System Not Ready.....	17
All/Perimeter Shortcut Key Arming	17
Arming an All/Perimeter System.....	18
All/Perimeter System Disarming.....	18
Disarming an All/Perimeter System.....	19
Disarming During an Alarm.....	19
Home/Sleep/Away and Home/Sleep/Away with Guest System.....	19
System Ready/System Not Ready Keypad Displays	19
Home/Sleep/Away and Home/Sleep/Away with Guest Shortcut Key Arming	19
Arming a Home/Sleep/Away or a Home/Sleep/Away with Guest System.....	20
Home/Sleep/Away and Home/Sleep/Away with Guest System Disarming	20
Disarming a Home/Sleep/Away or a Home/Sleep/Away with Guest System.....	21
Disarming During an Alarm.....	21
Extending Schedules	21
Keypad Shortcut Keys.....	22

Arming Function	22
Sensor (Fire) Reset Function.....	22
Monitor (Chime) Function	22
User Menu	23
Accessing the User Menu	23
User Menu Options.....	23
Menu Option	23
Alarm Silence.....	24
Using the Alarm Silence Function	24
Sensor Reset	24
Sensor (Fire) Reset Shortcut Key.....	24
Resetting the Sensors	24
Door Access	24
Using the Door Access.....	24
Armed Areas Display	25
Using the Armed Areas Function	25
Outputs On Off	25
Turning the Outputs ON and OFF	25
Browser Feature	25
Zone Status	26
Using the Zone Status Function.....	26
Browser Feature	26
Bypass Zones	26
Using the Bypass Zones Function	26
Browser Feature	27
Zone Monitor	27
Monitor (Chime) Shortcut Key.....	27
Testing your system's burglary protection	27
Using the Zone Monitor Function.....	27
Browser Feature	28
System Status	28
Using the System Status Function	28

Keypad Display	28	Fire Drill	42
System Test	28	Starting a Fire Drill test	42
Using the System Test Function	28	Ending a Fire Drill test.....	42
Using the Panic Zone Test (XR500N/E Only).....	29	System Setup	43
User Profiles	29	System Setup Record	43
Adding User Profiles.....	30	Keypad Record	43
Browser Feature	30	Key Fob Button Programming	44
Changing User Profiles	30	Area Names and Numbers Record	45
Browser Feature	31	Area	45
Deleting User Profiles.....	31	User Profiles Record	46
Browser Feature	31	User Codes Record	47
User Codes	33	Schedules Record	48
Adding User Codes.....	33	Holiday Date Record	49
Browser Feature	34	Output Record	49
Changing User Codes.....	34	Appendix A	50
Changing Own User Code.....	34	About the Display Events Section	50
Browser Feature	34	Using the Display Events	50
Deleting User Codes.....	34	Arming and Disarming Event Displays.....	51
Browser Feature	35	Keypad Display	51
Forgive Failure to Exit.....	35	Zone Event Displays	51
Ambush Code	36	Keypad Display	51
Schedules	36	Supervisory Event Displays	51
Setting Shift (S1 S2 S3 S4) Schedules	37	Keypad Display	51
Setting Output (OUT) and Door (DOOR) Schedules	38	User Code Change Event Displays	51
Setting Holiday ABC Schedules for S1, S2, S3, S4, OUT, and		Keypad Display	51
DOOR Schedules	39	Zone Bypass Event Displays	51
Setting Holiday Dates (HOL).....	40	Keypad Display	51
Extending Schedules (EXT).....	41	Door Access Event Displays.....	52
Setting the Date and Time	41	Keypad Display	52
Setting the System's Date and Time	41	About Door Access.....	52
Display Events	42	System Monitor Event Displays.....	52
Service Request	42	Keypad Display	52

Schedule Change Event Displays	53
Keypad Display	53
Wireless Jamming Event Displays	53
Keypad Display	53
Wireless Trouble Event Displays.....	53
Keypad Display	53
Appendix B	54
Zone Status Browser	54
Bypass Zones Browser	55
Zone Monitor Browser.....	55
Add User Codes Browser.....	56
Change User Codes Browser	56
Delete User Codes Browser	57
Add User Profiles Browser	57
Change User Profiles Browser	58
Delete User Profiles Browser	58
Output Groups Browser	59
Outputs On/Off Browser	59
Appendix C	60
User Disarm and Entry.....	60
Entering User Names	60
Appendix D	61
DMP Wireless Description	61
LED Status Operation	61

Appendix E.....	62
Easy Entry™ User’s Guide	62
Door Strike.....	62
Arming and Disarming an Area System.....	62
Arming and Disarming an All/Perimeter System	63
Arming and Disarming a Home/Sleep/Away System and a Home/Sleep/Away with Guest System.....	63
Disarming with Entry Delay.....	63
Appendix F.....	64
Email/Cell Phone Message User’s Guide	64
In Touch™ Text Messaging Commands	65
Arming All Areas with Text Message Commands.....	65
Arming Partial Areas with Text Commands.....	65
Disarming All Areas with Text Message Commands.....	65
Disarming Partial Areas with Text Message Commands	65
Cancelling an Alarm with Text Messaging.....	66
Turning Outputs On/Off/Momentary with Text Messaging.....	66
Check Armed Status Text Command	66
Subscribe to Text Messages	66
Frequently Asked Questions	67
Common Keypad Displays	68

Introduction

XR500 and XR100 Security Command™ Systems

This Guide covers operation of the XR500 Series and the XR100 Series Security Command™ system.

About Your Security System

The system has been designed with your safety and comfort in mind. It uses the latest in computer based technology to create the most advanced, user friendly security, fire, and access control system available.

The system combines ease of use with a simple to understand DMP keypad to offer the full range of features requested by today's security system owners.

Use the system to turn portions of your protection on or off by pressing a few keys, or have the system turn on or off automatically by entering a simple schedule. You can add, delete, and change personal user codes at any time or check the status of protection devices in the system.

Parts of the System

There are two main parts to the security system, the keypad and the keypad User Menu.

LCD Keypad

This is the device we have placed at certain locations throughout the premises that allow you to turn the system protection on and off using your personal user code.

Keypad User Menu

The keypad provides a simple User Menu containing all of the functions you need to fully operate your system such as changing the time of day or a personal user code.

A Note About False Alarms

One of the most important concerns facing the security industry today is false alarms. The accidental dispatching of police and fire agencies places others in jeopardy by limiting the response capability of those emergency service units.

As part of our commitment to reducing false alarms, we would like to encourage you to read this guide thoroughly. All the information contained here can help you quickly, and comfortably, learn the Security Command™ system operation. If you have any additional questions, or feel that you need more training, please do not hesitate to contact your alarm dealer.

Note: There may be a 30-second alarm communication delay pre-programmed at installation to allow disarming if a false alarm occurs. This delay is optional and can be removed or increased to 45 seconds by your alarm dealer.

Test Your System Weekly

It is recommended that you test the burglary portion of your system at least once each week. Testing should involve an active test of all doors, windows, and motion detectors connected to your system. If your system also has fire protection, call the service department to find out how this portion of your system should be tested.

Refer to the System Test section of this guide for instructions on testing the burglary portion of your system and refer to the Fire Drill section for instructions on testing your system fire bells.

Emergency Evacuation Plans

The National Fire Protection Association recommends that you establish an emergency evacuation plan to safeguard lives in the event of a fire or other emergency.

Draw a Floor Plan of Your Home or Business

On a clean sheet of paper, draw the walls, windows, doors, and stairs. Also draw any obstacles that a person may encounter while exiting the building such as large furniture or appliances.

Develop Escape Routes

Determine at least two routes the occupants in each room can take to safely escape. One route can be the most obvious such as the door. Another can be through a window that can be easily opened. If the window is high off the ground, an escape ladder should be provided.

Draw arrows on the floor plan to show escape routes from each room.

Decide Where to Meet

Prearrange a meeting place outside and away from where emergency personnel are likely to be working. A neighbor's house or across the street in front of the house are good locations. Always perform a head count to make sure all occupants safely exited. NEVER ENTER A BURNING BUILDING. If the head count shows one or more persons missing, give this information immediately to the authorities. Never enter a building to look for someone.

Practice Your Escape Plans

Devising an escape plan is only the beginning. For the plan to be effective everyone should practice escape routes from each room.

Early Detection

The best way to survive a fire or other emergency is to get out early. The installation of a fire alarm system, with smoke and carbon monoxide detectors in each room, can greatly decrease your risk of loss or injury.

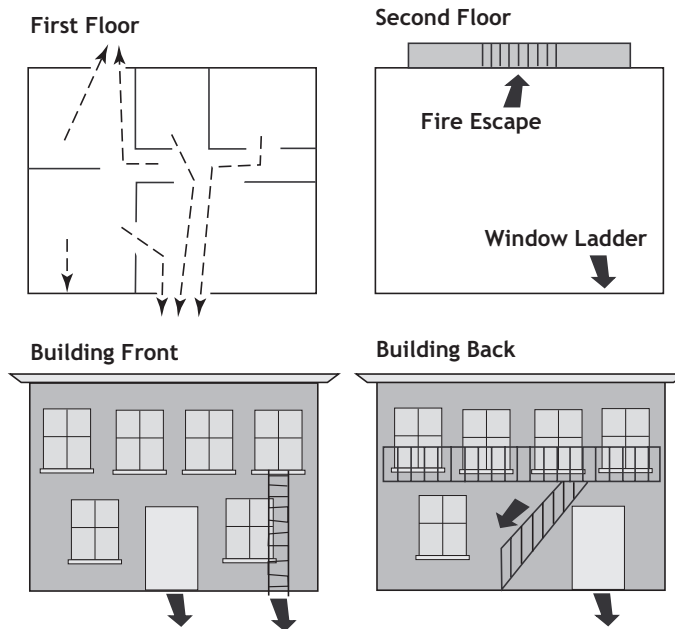

DMP Keypads

Your system may have one or more easy to use LCD keypads that allow you to properly operate the system.

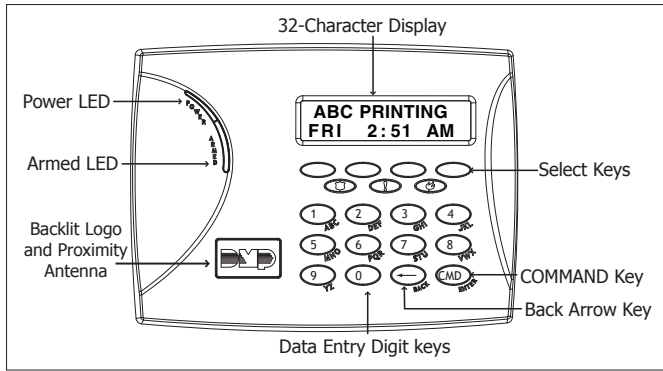

Thinline™/Aqualite™ Keypad

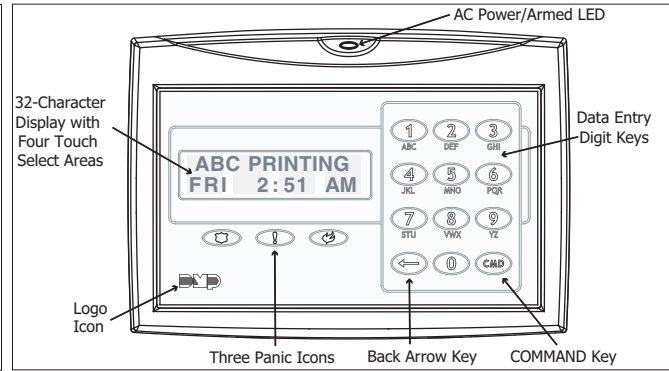

Clear Touch™ Keypad

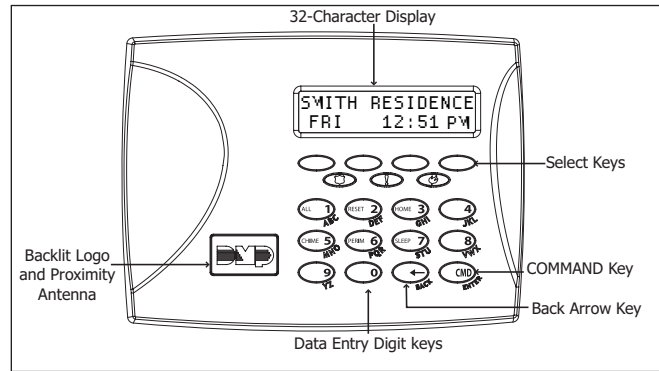

Thinline™ Wireless Keypad

The Select keys

Thinline™, Aqualite™ and Wireless Keypads:

There are four keys under the display called the Select keys. These keys are one of the features that make your system so easy to operate. They allow you to make selections by pressing the Select key under a choice shown in the display.

Note: For the purposes of this guide, when instructed to press the first Select key, press the far left Select key; the second Select key is the second from the left; third Select key is second from the right; and the fourth Select key is the far right key.

Clear Touch™ Keypads:

There are four Select Areas in the display. These Select Areas are one of the features that make your system so easy to operate. They allow you to make selections by touching the area to choose the item in the display.

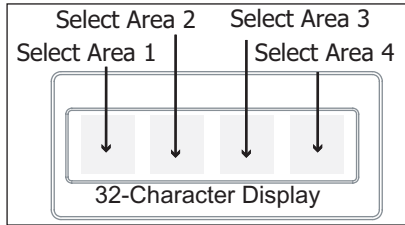

Clear Touch Select Areas

Note: For the purposes of this guide when using Clear Touch™ Keypads, when instructed to press the first Select key, touch Select Area 1; the second Select key touch Select Area 2; third Select key touch Select Area 3; and the fourth Select key touch Select Area 4.

Power/Armed LED

Thinline™ and Aqualite™ Keypads:

The Power LED indicates the panel Power status. It is recommended you contact the service department when the Power LED is off or blinks.

LED Operation	AC	Battery
ON (Steady)	OK	OK
OFF	Trouble	N/A
BLINKS	OK	Trouble

The Armed LED is ON steady anytime any burglary protection area is armed and is OFF when ALL areas are disarmed.

Clear Touch™ Keypads:

The LED indicates the Power and Armed status of the panel. Depending on the operation, the LED displays in Red or Blue as listed in the table.

Color and Activity	LED Operation
Blue Steady	Panel Disarmed, AC Power OK, Battery OK
Blue Blinking	Panel Disarmed, AC Power OK, Battery Fault
No Light	Panel Disarmed, AC Power Fault, Battery OK
Red Steady	Panel Armed, AC Power OK, Battery OK
Red/Blue Alternate	Panel Armed, AC Power OK, Battery Fault
Red Blinking	Panel Armed, AC Power Fault, Battery OK

Power/Armed Logo

Thinline™ Wireless Keypads:

The backlit logo on the keypad indicates the panel armed status and the keypad power status. Depending on the operation, the logo displays Red or Green as listed in the table.

Color and Activity	Armed Status	Keypad Power Status
Green Steady	Panel Disarmed	AC Power OK, Battery OK
Green Blinking	Panel Disarmed	AC Power OK, Battery Fault
No Light	Panel Disarmed	AC Power Fault, Battery OK
Red Steady	Panel Armed	AC Power OK, Battery OK
Red/Green Alternate	Panel Armed	AC Power OK, Battery Fault
Red Blinking	Panel Armed	AC Power Fault, Battery OK

Panic Functions

Your keypad may be set up to send a Panic, Emergency, or Fire report to the central station. This function is optional. If this option is programmed for your keypad, icons display below the top row Select keys/areas.

Thinline™, Aqualite™ and Wireless Keypads:

Press and hold the two Select keys adjacent to the desired icon for 2 seconds, until a beep from the keypad is heard.

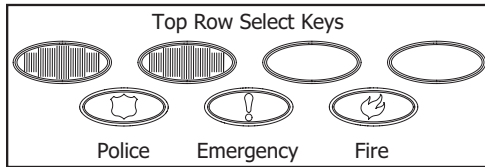

Thinline™/Aqualite™/Thinline™ Icon Keypad Panic Keys With Shaded Buttons To Indicate Police Panic Keys

Clear Touch™ Keypads:

Touch the icon for 2 seconds until a beep is heard.

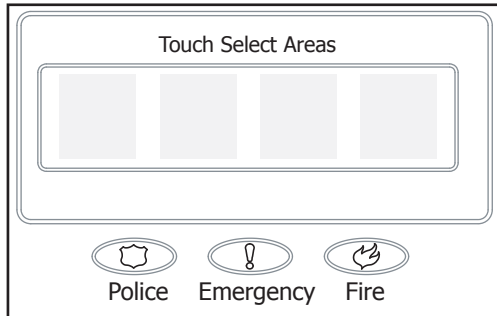

Clear Touch™ Keypad Panic Icons

7/0 Panic Function

Thinline™ and Aqualite™ Keypads:

Thinline™ and Aqualite™ Keypads may also be programmed at installation to allow the user to initiate an optional Panic alarm by simultaneously pressing and holding the 7 and 0 (zero) keys. When the 7 and 0 keys are pressed for a short time, the keypad sends a Panic alarm report to the central station.

Note: The 7/0 Panic Function is not available on Clear Touch™ or Thinline™ Icon or Wireless keypads.

Common Keys on All Keypads

Data Entry Digit keys

These keys allow you to enter your user code when arming or disarming or enter other information into the system.

COMMAND (CMD) key

The COMMAND key allows you to advance through the keypad displays, User Menu, or complete a data entry function.

Back Arrow (<←) key

The Back Arrow (<←) key is used to go back through the keypad displays while operating your system. You can press the Back Arrow key to back up through the list of functions in the User Menu or to erase the last character you entered.

Using the Keypad

Multi-lingual Display Option

Your system may be programmed to display the User Menu and Status Display text in multiple languages. When the COMMAND key is pressed, the option to choose the language displays. Select the language you want to use. The language chosen continues to display at this keypad until another language is chosen.

Keypad Displays Current Programming

Most User Menu options displayed at the keypad show the currently selected option in the panel memory. These options are either shown as a number, a blank, or a **NO** or **YES**. To change a number press any top row Select key. The current option is replaced with a dash. Press the number(s) on the keypad you want to enter as the new number for that option.

It is not necessary to enter numbers with leading zeros. The panel automatically right justifies when you press the COMMAND key. To change an option that requires a **NO** or **YES** response, press the top row Select key for the response not selected. For example, if the current option is **YES** and you want to change it to **NO**, press the third Select key. The display changes to **NO**. Press the COMMAND key to go to the next option.

Multiple Displays (XR500 System Only)

For some User Menu options, such as **Access Areas** under **User Profiles** there are several displays containing lists. For example, when using **Access Areas**, areas 1 through 32 display on four separate displays. First, areas 1 through 8 display. Press the COMMAND key to display areas 9 through 16. Press the COMMAND key again to display areas 17 through 25. Press the COMMAND key one more time to display areas 26 through 32.

Note: Only areas pre-programmed at installation can be viewed.

Asterisks in Area Armed Displays

Asterisks display next to a programming option that is already selected. As shown in the example, options that are selected to display the current programming selection have an asterisk next to the number. Those that are not selected simply display the number. In the Areas example, areas 3, 8, 9, 15, 19, 23, 25, and 31 are not selected. The area numbers with asterisks are selected.

*1	*2	3	*4	*17	*18	19	*20
*5	*6	*7	8	*21	*22	23	*24
9	*10	*11	*12	25	*26	*27	*28
*13	*14	15	*16	*29	*30	31	*32

To select or deselect a number, simply enter the number using the digit keys on the keypad. This same scheme is used when viewing the panel armed status and other programming and operational functions. Remember to press the COMMAND key to display the rest of the area numbers on XR500 systems.

Note: XR100 Systems support 8 areas.

32-Character Name Display

Your system may be programmed to display up to 32-character names. When a name is displayed at the keypad, the top line of the display shows the first 16 characters. If a name is longer than 16 characters, after two seconds the display automatically scrolls to display the remaining characters.

If displayed as part of the Status List, the entire 32-character name is displayed for four seconds followed by the number and status.

Keypad User Options

The User Options allow you to make adjustments to your keypad to best fit your environment and needs.

Thinline™, Aqualite™ and Wireless keypads: Press and hold the Back Arrow and COMMAND keys for two seconds. The keypad display changes to SET BRIGHTNESS. Press the COMMAND key to display the next option or the Back Arrow key to exit.

Clear Touch™ keypads: Touch and hold the center of the logo icon for two seconds. The display changes to SET BRIGHTNESS. Touch the COMMAND (CMD) key to display the next option or touch the Back Arrow (←) to exit the User Options function.

Backlighting Brightness

At the SET BRIGHTNESS display, use the left Select key to lower the keypad brightness. Use the right Select key to increase the brightness.

Note: If the brightness level is lowered, it temporarily reverts back to maximum intensity whenever a key is pressed.

On Thinline™ or Aqualite™ keypads: This sets the LCD display, AC LED, and the Green keyboard backlighting brightness level.

On Clear Touch™ keypads: The user selected brightness may be set to off which allows the glass graphic display to turn off (clear glass). Simply touch the glass anywhere and the backlight illuminates for data entry. When the speaker is sounding, the backlight illuminates at one-half (1/2) brightness.

On Wireless keypads: This sets the LCD display, keyboard, and logo backlighting brightness level.

Internal Speaker Tone

Set the tone of the keypad internal speaker. At the SET TONE display, use the top left Select key to make the tone lower. Use the right Select key to make the tone higher.

Volume level

Set the volume level of the keypad internal speaker for key presses. During alarm, trouble, and prewarn conditions, the volume is always at maximum level. At SET VOLUME LEVEL, use the left Select key to lower the keypad volume. Use the right Select key to raise the volume.

Model Number

Thinline™, Aqualite™, and Wireless Keypads:

The keypad model number, firmware version, and date display, but cannot be changed.

Serial Number

Thinline™ Wireless Keypads:

The serial number assigned to the keypad displays. Press the Back Arrow key to exit the User Options function.

Keypad Address

The current address assigned to the keypad displays, but cannot be changed. Press the Back Arrow key to exit the User Options function.

Special Keypad Tones

Your keypad also contains a small speaker that alerts you about events as they occur on your system. For burglary alarms, as soon as the first digit key is pressed to enter a user code, the keypad tone stops. If a valid user code is not entered or an invalid user code is entered within five seconds, the tone begins sounding again. Below are brief descriptions of the different tones you hear from the keypad.

Fire Alarm tone: An intermittent sweeping siren that sounds until the fire alarm is silenced. From LCD keypads only.

Burglary Alarm tone: A constant siren tone that continues until the alarm is silenced. From LCD keypads only.

Key press tone: A short beep each time you press a key on the keypad and it is acknowledged by the system.

Prewarn tone: A continuous pulsed tone that sounds when you open an entry delay door on a system that is armed (turned on) reminding you to disarm the burglary protection. The tone silences as soon as the first user code digit key is pressed. If a valid user code is not entered or an invalid user code is entered within five seconds, the prewarn tone begins sounding again.

Exit tone: A continuous pulsing tone that sounds during the exit countdown just after arming all areas of your system to remind you to exit the premise. At ten seconds prior to the end of the countdown, the rate of pulsing increases.

Monitor tone: A pulsed tone for one second, one pulse only that sounds whenever a door or window is opened while you are using the zone monitor function from the User Menu. LCD keypads sound a doorbell chime. See Zone Monitor.

Note: When toggling to a RMV monitor state, the Zone Monitor tone does not sound.

Trouble tone: A steady tone indicating a trouble condition on your system. Press a Select key to silence.

What to do when the trouble tone sounds

You can silence the trouble tone by pressing any key. This only silences the keypad and does not correct the condition that originally caused the trouble.

DMP Wireless

Your system may have DMP wireless devices including key fob(s). There are three types of DMP wireless key fobs available:

- 4-Button Model 1145 Key Fob
- 2-Button Model 1146 Key Fob
- 1-Button Model 1147 Key Fob

The drawing shows the button layout for all three models. Each button on the key fob is programmed to perform a specific action. The button names are listed below.

- TOP = the Key Fob Top button
- BTM = the Key Fob Bottom button
- LFT = the Key Fob Left button
- RGT = the Key Fob Right button

The button programming list for the key fob(s) connected to your system is located in the System Setup section of this guide. Refer to Appendix D for LED Status operation information. Specific function labels can be added to each button to indicate button operation.

For best operation, allow the LED to light and turn off before pressing another button. The key fob may not complete sending the signal for the button press if another button is pressed too soon.

If there is no LED light, the battery for your key fob may need replacing or you could be out of range.

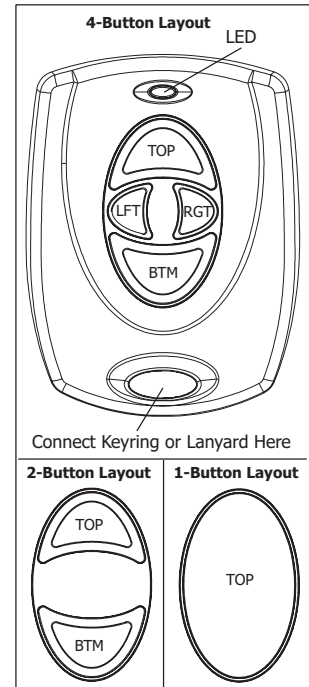

Key Fob Examples and Button Names

Special Wireless Displays

Your system may use wireless transmitters to send alarm and trouble information from the protection devices to the panel. Wireless systems have a few unique keypad displays.

BACK DOOR - LOBAT - (Low Battery) The battery in a wireless transmitter is low. (BACK DOOR is used as an example only.)

BACK DOOR - MISNG - (Missing) The panel is not receiving the wireless transmitter periodic test report.

WIRELESS - TRBL - (Trouble) Some part of your wireless system is operating improperly. Call the service department for assistance.

WIRELESS RECEIVER JAMMED - ALARM - Your system may be programmed for wireless interference detection and, if displayed, your wireless receiver has detected a jamming signal while the system is armed.

WIRELESS RECEIVER JAMMED - TRBL - (Trouble) Your system may be programmed for wireless interference detection and, if displayed, your wireless receiver has detected a jamming signal while the system is disarmed.

Special Keypad Displays

As you use your system, you occasionally see a keypad display that asks you to enter a code or that describes a condition on the system. Below are some examples of the keypad displays:

ALARM

A 24-hour zone (for example fire or panic) or an armed burglary zone has been tripped. Your system may sound bells or sirens.

TRBL (TROUBLE)

There is a problem with a protection device or system component. This display is accompanied by a description of the problem.

ALARM NOT SENT

The alarm signal was aborted and was not sent to the central station because a user code was entered to disarm the system before the alarm signal was sent to the central station. Also, your system may be pre-programmed at installation to send an Abort signal to the Central Station that an alarm occurred but was not sent because the user entered a code before the delay time expired. Refer to the Introduction section of this guide.

ALARM CANCELLED

An Alarm signal just sent to the central station was cancelled because a user code was entered to disarm the system after the alarm was sent. Also, an Alarm Cancel signal is sent to the Central Station.

ALARM VERIFIED

A valid burglar alarm has occurred and has been manually verified by the user. The alarm system also transmits a VERIFY message to the Central Station.

ENTER CODE OR PRESENT CARD

The system requires you to enter your user code or present your user card/proximity credential to a keypad or card reader. User codes or reads can be required for turning your system on (arming), turning your system off (disarming), and many other functions.

As you enter your user code, the keypad display shows an asterisk (*) in place of each digit pressed. This keeps others from seeing your user code on the display as it is entered.

TRY AGAIN OR INVALID CODE/CARD/PIN

The user code, card read, or PIN you have used is not recognized by the system. Check the user code or PIN or present the card to the reader again.

INVALID PROFILE

All user codes have a profile that allow the user to only access certain functions. When users attempt functions outside their authority, the INVALID PROFILE message displays.

INVALID AREA

A user has attempted a door access for an area they are not assigned.

INVALID TIME

A user code assigned to a specific schedule is entered outside of the valid schedule. See Schedules and User Codes.

ARMED AREA

A user has attempted a door access to an armed area to which they do not have arming and disarming authority.

FAILED TO EXIT (ANTI-PASSBACK)

Anti-passback requires users to properly exit (egress) an area they have previously accessed. If they fail to exit through the proper card reader location, they are not granted access on their next attempt. A Failed to Exit message appears when a user assigned the anti-passback option attempts to re-enter an area which they did not exit properly. The user must exit the area through the proper door. If not possible, your system administrator should select the Forgive option in the User Codes menu option.

SYSTEM TROUBLE or SERVICE REQUIRED

There is a problem with one or more of the components in your system. Contact our service department as soon as possible.

SYSTEM BUSY

The system is performing another task of a higher priority. This usually only takes a few moments.

TEST IN PROGRESS

The system is currently being tested by an installation or service technician.

Email/Cell Phone Messages

Your system may be programmed at installation to send a variety of messages to your personal email and cell phone.

The message option uses your security system's reporting capability to send reports using an email address or cell phone number in much the same way as someone sending an email would do. You can receive reports of alarms, troubles, or system arming and disarming and know at a glance your system status. See Appendix F for more information.

In Touch™ Text Messaging Commands

Your system may be programmed to allow simple text messages to be sent to the security system to perform basic user operations. By texting a message from your cell phone or PDA, the following actions can be performed: Arm/Disarm, check Armed Status, Cancel Alarm, and turn Outputs On/Off. See Appendix F for more information.

Understanding Security System Terms

Throughout this guide, and in some displays on your keypad, you may see certain words or phrases that might be unfamiliar. Below are some terms you may see here and on your keypad display:

Access (Door Access)

Entry/Exit doors that are used to restrict access to the building or provide door access to authorized users. When a user code is entered at the keypad by entering a code or presenting a card to a reader, the system verifies authority and unlocks the door for a short period of time. See Easy Entry User's Guide in Appendix E.

Areas

An area is made up of burglary zones that can be armed or disarmed together. One area might consist of the office doors and windows. When you arm the office, these zones arm together and sound an alarm if opened.

Arming

Turns on the burglary protection in one or more areas of the system. When armed, the system is able to sound alarm bells or sirens and, if monitored, send alarm reports to a central station when a burglary zone is tripped.

Fire, panic, and other 24-hour devices are always turned on and do not need to be armed.

Central Station Monitoring

Your system can also be programmed to automatically send alarm, trouble, and arming and disarming reports to a central station. Operators at the central station dispatch the appropriate authorities or contact you with the specific event information.

Disarming

Turns off one or more areas of the system. When disarmed, the system does NOT sound alarms or send alarm reports to a central station when a burglary zone faults.

Fault

You may see the keypad display FRONT DOOR –FAULT. This means that there is a problem with the front door, such as the door being open when you are arming the system. If you see a –FAULT display, attempt to correct the problem (in this case shut the door). After the zone is in a normal state, you may arm the system. You may also bypass the zone and then arm the system.

Zone

A zone refers to one or more protected openings (doors or windows) or protection devices (motion or glassbreak detectors) grouped together under the same zone name and number.

Often, similar devices in the same general location share the same zone. For example, the windows on the east side of the premises can all be grouped together in a zone named E. WINDOWS.

Instant Zone

Interior protection devices and perimeter devices, such as exterior windows, passive infrared detectors (PIR), and non entry doors, are typically not programmed with delay times. If these zones are tripped while the system is armed, an alarm instantly occurs.

24-hour Zone

A 24-hour zone is not turned on or off by arming or disarming your system. Some examples of 24-hour zones are fire zones, panic zones, and temperature control zones.

Entry or Exit zone

Almost all systems have one or more doors through which you can access the premises. These doors are programmed with a delay time to allow you to enter or exit without setting off the alarm.

When you arm the system, activity on this zone is ignored until the exit delay time expires. Once that time has expired and the system is fully armed, opening the door causes the panel to start the entry delay time. During the entry delay time, you must enter a valid user code to disarm the system or an alarm occurs.

Status

Status is a feature that automatically displays the armed or disarmed status of your system on the keypads. Alarm or trouble conditions on a zone or a system monitor such as AC or battery trouble can also display. There are two types of status information available: Armed Status and Status List.

Status List

The keypad Status List displays any alarm or trouble condition on a zone, and any trouble condition on an internal system monitor. The system monitors include the AC power, battery power, panel box tamper, printer, and phone lines. If more than one alarm or trouble condition occurs at the same time, the keypad sequences this information on its display.

If the alarm is from a 24-hour zone or a system monitor, it remains in the Status List until it restores. If one or more armed burglary zones trip at the same time, the last one to trip remains in the Status List. This is to ensure that if a burglary has occurred the last zone tripped remains displayed even if it has been restored.

Armed Status

Armed Status is the keypad display of the current armed condition of areas within your security system.

If your system is set up as an Area system with areas one to eight, the display shows: 1 2 3 4 5 6 7 8. When you arm areas 1, 3, 5, and 7 the keypad displays: 1 3 5 7.

If your Area system is setup with nine or higher areas and the system is armed, the display reads: ALL SYSTEM ON or SYSTEM ON. Refer to Checking Armed Areas for information about checking the armed areas.

If your system is set up as a Home/Sleep/Away or All/Perimeter system, one of the following displays indicate the current Armed Status:

The keypad displays

HOME SYSTEM ON

When

The perimeter is armed in a Home/Sleep/Away system.

PERIMETER ON

The perimeter is armed in an All/Perimeter system.

ALL SYSTEM ON

All areas are armed.

SLEEP SYSTEM ON

The perimeter and interior are armed but the bedroom area is disarmed.

If your system is set up as a Home/Sleep/Away with Guest system, the arming status of the main system is the same as a standard Home/Sleep/Away system. The current arming status of the Guest systems displays as follows:

The keypad displays

HOME GUEST 1 ON

When

The first guest house perimeter is armed in a Home/Sleep/Away with Guest system.

SLEEP GUEST 1 ON

The first guest house perimeter and interior are armed but the bedroom area is disarmed.

ALL GUEST 1 ON

All first guest house areas are armed.

Note: The XR100 system allows one guest house system while the XR500 allows two guest house systems.

Also, for keypads that include an Armed LED, the Armed LED is ON steady when ALL areas assigned to that keypad are armed and OFF when any area assigned to that keypad is disarmed.

View Zone Status

To view disarmed zones that are in fault, press any Select key when the status list displays.

Browser Feature

Refer to Appendix B at the back of this guide for diagrams showing you how to use the built-in browsers.

Arming and Disarming

General Arming Operation

Your system has been programmed to operate in one of four configurations: Area, All/Perimeter, Home/Sleep/Away, or Home/Sleep/Away with Guest.

- **Area** – Your burglary protection is divided into up to 32 areas. Each area can have a custom name, be turned on or off independently of other areas, and limit access to only those users with proper authority.

- **All/Perimeter** – Your burglary protection is divided into two areas: Interior and Perimeter.

Perimeter arming is when you are staying inside but want the comfort of knowing the exterior doors and windows are armed. Perimeter arming allows you to move freely about inside without setting off any interior alarms.

All arms both the Perimeter and the Interior of the system. You want to arm both of these areas when leaving the building and no one is left inside.

- **Home/Sleep/Away** – Your burglary protection is divided into two or three areas: Perimeter, Interior, and Bedrooms.

Home (Perimeter) arming is when you are staying inside but want the comfort of knowing the exterior doors and windows are armed.

Sleep (Optional) (Perimeter and Interior) arms all areas except those near bedrooms and nighttime areas.

Away (Perimeter, Interior, and Bedrooms) arms all three areas when you leave the building and no one is left inside.

- **Home/Sleep/Away with Guest** – Your burglary protection has a main house system and up to two guest house systems (XR100 has 1 guest house system while XR500 offers 2). Each house is separate and works just like the Home/Sleep/Away system previously mentioned.

Regardless of which configuration is programmed, much of the operation is similar. Throughout this guide, any differences between the systems are noted for your convenience.

Arming Functions

Arming or Disarming: You can arm and disarm all areas at one time or each area individually. You can only arm or disarm areas authorized for your user code.

Arm All or Selective Arming: After entering your user code, the system allows you to arm either all of the areas to which you have access or one or more selected areas. If you choose to arm all areas, the system begins verifying that all zones in those areas are in a good condition. If you choose to arm selected areas, the system prompts you to choose the areas you want to arm.

After making your arming selection, the keypad displays any zones that are currently bypassed. These zones remain bypassed until the system is armed and then disarmed. Any 24-hour zones in a faulted condition also display.

Bypassing Zones: Before arming, the system verifies that all doors, windows, and other protection devices to be armed are in normal condition. If everything is verified, the system arms. If there is a problem on one or more burglary zones, the system cannot arm until the problem is corrected. If the problem is simply an open door or window, correct the problem and try arming again.

If the problem cannot be corrected, you can force arm or bypass the zone or wait until the zone can be repaired by a service technician. A force armed zone is ignored by the system until it restores to normal. A bypassed zone is ignored by the system during the entire armed period. A zone remains bypassed until the system is disarmed.

In some cases, you might see the keypad display FRONT DOOR – FAULT. The keypad then displays priority zone which is a zone that cannot be bypassed. The problem on the zone must be corrected before the system can be armed.

When choosing to bypass a protection device or zone, there may be a pre-programmed maximum number of zones (up to 8) that can be bypassed in an area when that area is being armed. This limit is programmed at installation.

Arming Messages:

For **Area systems** the keypad briefly displays SYSTEM ON if only selected areas are armed. The keypad briefly displays ALL SYSTEM ON when all areas in the system are armed.

For **All/Perimeter systems** the keypad briefly displays PERIMETER ON if only selected areas are arming. The keypad briefly displays ALL SYSTEM ON when all areas in the system are armed.

For **Home/Sleep/Away systems** the keypad displays HOME SYSTEM ON or SLEEP SYSTEM ON if only selected areas are arming. The keypad briefly displays ALL SYSTEM ON when all areas in the system are armed.

For **Home/Sleep/Away with Guest systems** the main system arms the same as a Home/Sleep/Away system. A keypad assigned to the first guest house system displays HOME GUEST 1 ON or SLEEP GUEST 1 ON if only selected areas are arming. The keypad displays ALL GUEST 1 ON when all areas in the guest house system are armed.

Exit Delay: The keypad then displays the exit delay time as it counts down. Your system may be pre-programmed at installation to beep the exit delay tone at eight-second intervals until the last 10 seconds when the keypad beeps at three-second intervals. After exiting the building, if you re-enter during the countdown the exit countdown restarts, allowing additional time to then disarm or again exit the building during the countdown. This restart can occur only one time. When the exit delay time expires, all disarmed zones are armed.

Note: If your system uses a keyswitch to arm an area, the exit delay time does NOT show on the keypad display.

When you arm both the Perimeter and Interior to leave the building but then you do not exit by the time the exit delay ends, the system automatically arms but the interior area(s) will remain disarmed because you have not exited.

Should you exit the building and the door does not close properly, your system may be programmed so that when the exit delay countdown ends, then the entry delay starts and the bell will sound to alert you to the situation. Enter your user code to stop the bell and disarm the system. Rearm the system, exit the building, and make sure the door is securely closed.

ONE MOMENT . . . Message: If your system is monitored, it may be programmed to wait for the arming report transmission to the central station before displaying the armed message. This verifies your phone lines are working properly. While the system is waiting for the transmission, the display reads ONE MOMENT... If the report is received, the keypad displays the armed message. If the report is not received, the keypad displays LOCAL ALARM ONLY before displaying the armed message.

Note: Your system may be pre-programmed at installation to:

- send arming or zone bypassing reports to a central station
- arm and/or disarm specific areas at specific keypads.

Key Fob Arming

Press and hold the key fob button programmed for Arming or the Toggle arm/disarm button. The Red LED two-second acknowledgement light indicates All System On. The Green/Red two-second acknowledgement light indicates System On with some areas armed.

Key Fob Disarming

Press and hold the key fob button programmed for Disarming or the Toggle arm/disarm button. The Green LED two-second acknowledgement light indicates All System Off.

Area System Arming Operation

Area Assignment: Your security system has been set up into separate areas. The number of areas and their names are listed on the table in System Setup.

Arming the Area System

1. Press the COMMAND key until ARM DISARM is displayed.
2. Select ARM to arm the system.
3. Enter your user code if required. The keypad displays ALL? NO YES.
4. Select NO to arm only selected areas. Go to step 5. Select YES to arm all areas authorized for your user code. Go to step 6.
5. If you selected NO in step 4, the display begins to list each area to which you have access followed by NO YES.
Example: OFFICE NO YES
 - 5a. Select YES for each area you want to arm.
 - 5b. Select NO for each area you do not want to arm.
6. The system displays any bypassed zones or faulted 24-hour or Priority zones. A faulted Priority zone cannot be armed.
7. At this point you can force arm or bypass any faulted zones. A zone that is force armed is restored into the system if it later returns to normal. A zone that is bypassed remains bypassed until the system is disarmed. See steps 7a through 7d.

7a. If a problem exists on a zone, the zone name and problem is shown followed by: OKAY BYPASS STOP.

7b. Select **OKAY** to force arm the faulted zone.

7c. Select **BYPASS** to bypass all faulted zones being displayed.

Note: 24-hour zones cannot be bypassed.

7d. Select **STOP** to stop the system from arming. Correct the zone problem(s) and return to step 1.

Your system may be programmed to require a user code that has authorization to force arm or bypass a faulted zone. To force arm or bypass a faulted zone, the system asks you to enter a user code.

8. The display reads SYSTEM ON if at least one area in the system is armed, and ALL SYSTEM ON if all areas in the system are armed.

Note: Your system may be pre-programmed at installation for the Instant Arming option.

9. The keypad next displays EXIT: ## INSTANT and begins to count down the number of seconds remaining for you to exit. When the delay expires, the exit zones are armed.

10. You can select INSTANT while EXIT: ## INSTANT is displayed to immediately arm all exit zones and make them instant. The keypad displays INSTANT.

Quick Arming

To quickly arm a desired area, enter the area number followed by the COMMAND key when the ALL? NO YES option displays.

Checking the Armed Areas

After you have armed the system, you may press any Select key to check the armed areas when ALL SYSTEM ON or SYSTEM ON displays. The keypad then displays CHK ARMED AREAS: NAME NBR LIST.

Select NAME to list all of the armed areas by name. Select NBR to enter the area number you would like to check. Select LIST to list all of the armed areas by number.

Area System Disarming Operation

While the system is armed, you can only enter the premises through an entry/exit delay door without causing an alarm. After opening the door, the keypad sounds a prewarn tone to remind you to disarm the system. You must disarm the system before the entry delay time expires or an alarm on the door zone occurs.

During the entry delay time, the keypad displays ENTER CODE: and the name of the zone causing the entry delay. Enter your code to disarm the system. Only those areas assigned to your code disarms.

Note: The prewarn tone silences as soon as the first user code digit key is pressed. If a valid user code is not entered or an invalid user code is entered within five seconds, the prewarn tone begins sounding again.

Schedules: If you have programmed schedules for your system and a code is entered outside of a schedule and that code does not have authorization to disarm outside of schedules, the keypad displays INVALID TIME. This lets users know that they are attempting to disarm outside of their authorized time.

All or Selective Disarming: After entering your user code, the system allows you to disarm either all of the areas to which you have access or just selected areas. If you choose to disarm all areas, the system automatically disarms them. If you choose to disarm selected areas, the area names display on the keypad.

Alarm Display: After disarming, the keypad displays any zones that tripped or any transmission problems that occurred during the armed period. All burglary zones are then disarmed and any bypassed zones are automatically reset.

Disarmed Message: The keypad displays ALL SYSTEM OFF after the system disarms.

Central Station Report: Your system may be pre-programmed at installation to transmit a system disarming report to the central station.

Door Access Disarming: Your system may be programmed to allow area disarming when a card is presented to a door access reader located outside of the building. Simply present your card to the reader and after the card code is validated for the appropriate authority, a door access is granted and your matching areas are automatically disarmed. See the Easy Entry™ User's Guide in Appendix E.

Disarming the Area System from the keypad

1. Press the COMMAND key until ARM DISARM displays. During entry delay this process starts at step 3.
2. Select DISARM to disarm areas.
3. The keypad displays ENTER CODE: . Enter your user code and press COMMAND. The keypad displays ALL? NO YES.
4. Select YES to disarm all areas authorized for your user code.

Select NO to disarm only certain areas individually. The keypad then displays the name of each area authorized for your user code followed by the NO YES display.

Select YES to disarm the area displayed.

Select NO to not disarm the area and display the next area.

5. If you are disarming the system out of a normally scheduled time and you have the authority to extend a schedule, the keypad then displays 2HR 4HR 6HR 8HR. Select the number of hours to extend the schedule.

Note: If you do not have the authority to extend a schedule, this option does not display.

6. After all areas have displayed and schedules extended, any alarms or communication problems that occurred during the armed period display.
7. If all areas have been disarmed, the keypad next displays ALL SYSTEM OFF.

Quick Disarming

To quickly disarm a desired area, enter the area number followed by the COMMAND key when the ALL? NO YES option displays.

All/Perimeter System Arming

Area Assignment: Your security system is divided into two separate areas. Motion detectors, inside doors, and other interior protection devices are assigned to the Interior area while windows and exterior doors are assigned to the Perimeter area.

Perimeter or All: When arming an All/Perimeter system, the keypad displays PERIM ALL. If you select ALL, you are arming both the Perimeter and the Interior areas of the system. You will want to arm both of these areas when leaving the premises with nobody left inside. Selecting PERIM arms only the perimeter of the system. Perimeter arming is when you're staying inside but want the comfort of knowing the exterior doors and windows are armed. Perimeter arming allows you to move freely about inside without setting off any interior alarms.

Instant: During the exit delay time, you can cancel the exit and entry delays and cause all zones to be instant zones. Just press the far right Select key under INSTANT while the exit delay is displayed. This immediately arms the exit zones. However, no entry delay is provided and an alarm will occur should an entry door be opened.

System Ready/System Not Ready

When all zones in the system are in a normal condition and can be armed without bypassing, the keypad displays SYSTEM READY. If there are one or more zones that are not in a normal condition, the keypad displays SYSTEM NOT READY. Pressing any Select key during this display shows the zone number and name allowing you to investigate the problem.

All/Perimeter Shortcut Key Arming

Arm Perimeter — Press 6 for 2 seconds.

Arm All — Press 1 for 2 seconds.

Arming an All/Perimeter System

1. Enter your 4-digit user code. The keypad displays PERIM ALL.
2. Select PERIM to arm the Perimeter area only.
3. Select ALL to arm both the Perimeter and Interior areas.
4. The keypad displays zones that have been bypassed prior to arming and zones that are now in a faulted condition.
5. At this point you can force arm or bypass any faulted zones. A zone that is force armed is restored into the system if it later returns to normal. A bypassed zone remains bypassed until the system is disarmed. See steps 5a through 5d.
 - 5a. If a problem exists on any zones, the zone name and problem display followed by: OKAY BYPASS STOP.
 - 5b. Select OKAY to force arm the zone(s) before arming.
 - 5c. Select BYPASS to bypass the zone(s) before arming.
 - 5d. Select STOP to stop the system from arming. Correct the zone problem(s) and return to step 1.
6. The keypad displays PERIMETER ON if only the perimeter is being armed and ALL SYSTEM ON if both the perimeter and interior are being armed.
7. The keypad next displays EXIT: ## INSTNT and begins to count down the number of seconds remaining for you to exit. When the delay expires, all zones are armed.
8. You can select INSTNT while EXIT: ## INSTNT displays to immediately arm all zones and make them instant. The keypad displays INSTANT. When you select INSTANT, any entry/exit zone that trips immediately activates an alarm and the exit delay countdown immediately stops.

9. When the system is fully armed, the keypad displays PERIMETER ON for perimeter arming and ALL SYSTEM ON for perimeter and interior arming.

All/Perimeter System Disarming

Disarming: While the system is armed, you can only enter the premises through an entry/exit delay door without causing an alarm. After opening the door, the keypad sounds a prewarn tone to remind you to disarm the system. You must disarm the system before the prewarn tone expires or an alarm on the door zone will occur.

During the prewarn tone, the keypad displays ENTER CODE:. Enter your user code to disarm the system.

Schedules: If you have programmed schedules for your system and a user code is entered outside of a schedule, the keypad displays INVALID TIME. This lets the user know that they are disarming outside of their authorized time.

Alarm Display: After disarming, the keypad displays any zones that tripped or any transmission problems that occurred during the armed period. All burglary zones are then disarmed and any bypassed zones are automatically reset.

Disarmed Message: The keypad displays ALL SYSTEM OFF after the system disarms.

Central Station Report: A report of the system disarming can be transmitted to the central station. This is optional and can be programmed for you at any time.

Disarming an All/Perimeter System

1. During the entry delay time, the keypad displays ENTER CODE:. Enter your 4-digit user code.
2. The keypad then displays any zones that went into alarm or any communication problems that occurred during the armed period.
3. The keypad next displays ALL SYSTEM OFF to confirm the system is disarmed.

Disarming During an Alarm

1. While the alarm bell or siren sounds, enter your user code to silence the alarm. The keypad tone silences as soon as the first key is pressed.

For a burglary alarm, the keypad displays CANCEL VERIFY.

This allows you to investigate the alarm prior to disarming the system. This display remains on the keypad until a selection is made, the Back Arrow is pressed, or the internal system bell cutoff timer expires.

2. If a valid alarm has not occurred, select CANCEL to disarm the system and cancel the alarm.

The keypad next displays ALL SYSTEM OFF to confirm the system is disarmed.

OR

If the alarm is valid, select VERIFY to send a verify message to the Central Station.

Home/Sleep/Away and Home/Sleep/Away with Guest System Arming

Area Assignment: Your security system is divided into two or three separate areas. Motion detectors, inside doors, and other interior devices are assigned to an Interior and Bedroom areas while windows and exterior doors are assigned to a Perimeter area.

Arming the system: When arming a Home/Sleep/Away or a Home/Sleep/Away with Guest system, the keypad displays HOME AWAY or HOME SLEEP AWAY. If you select AWAY, you arm all areas of the system. You will want to arm all areas when leaving with nobody staying inside. Selecting HOME arms only the Perimeter of the system. Perimeter arming is when you are staying inside but want the comfort of knowing the exterior doors and windows are armed. Perimeter arming allows you to move freely about inside without setting off any interior alarms. Selecting SLEEP arms the Perimeter and Interior devices but leaves devices near bedrooms or other nighttime areas off.

System Ready/System Not Ready Keypad Displays

When all zones in the system are in a normal condition and can be armed without bypassing, the keypad displays SYSTEM READY. If there are one or more zones that are not in a normal condition, the keypad displays SYSTEM NOT READY. Pressing any top row Select key during this display shows the zone number and name allowing you to investigate the problem.

Home/Sleep/Away and Home/Sleep/Away with Guest Shortcut Key Arming

Arm Home – Press 3 for 2 seconds to arm the perimeter.

Arm Sleep – Press 7 for 2 seconds to arm the perimeter and interior areas and leave the bedroom area off.

Arm Away – Press 1 for 2 seconds.

Arming a Home/Sleep/Away or a Home/Sleep/Away with Guest System

1. Enter your 4-digit user code. The keypad displays HOME SLEEP AWAY.
2. Select HOME to arm the Perimeter only.
3. Select SLEEP to arm the Perimeter and Interior.
4. Select AWAY to arm the Perimeter, Interior, and Bedroom.
5. The system displays any Bypassed zones or faulted 24-hour or Priority zones. A faulted Priority zone cannot be armed.
6. At this point you can force arm or bypass any faulted zones. A zone that is force armed will be restored into the system if it later returns to normal. A zone that is bypassed will remain bypassed until the system is disarmed. See 6a through 6d.
 - 6a. If a problem exists on a zone, the zone name and problem is shown followed by OKAY BYPASS STOP.
 - 6b. Select OKAY to force arm the zone(s) before arming.
 - 6c. Select BYPASS to bypass the zone(s) before arming.
 - 6d. Select STOP to stop the system from arming. Correct the zone problem(s) and return to step 1.
7. A Home/Sleep/Away system keypad displays HOME SYSTEM ON if you selected HOME, SLEEP SYSTEM ON if you selected SLEEP, and ALL SYSTEM ON if you selected AWAY.

A Home/Sleep/Away with Guest system keypad displays HOME GUEST 1 (or 2) ON if you selected HOME, SLEEP GUEST 1 (or 2) ON if you selected SLEEP, and ALL GUEST 1 (or 2) ON if you selected AWAY.
8. The keypad next displays EXIT: ## INSTNT and begins to count down the number of seconds remaining for you to exit. When the delay expires, the exit zones are armed.

9. You can select INSTNT while EXIT: ## INSTNT is displayed to immediately arm all exit zones and make them instant. The keypad displays INSTANT.

Home/Sleep/Away and Home/Sleep/Away with Guest System Disarming

Disarming: While the system is armed, you can only enter the premises through an entry/exit delay door without causing an alarm. After opening the door, the keypad sounds a prewarn tone to remind you to disarm the system. You must disarm the system before the prewarn tone expires or an alarm on the door zone will occur.

During the prewarn tone, the keypad displays ENTER CODE:. Enter your user code to disarm the system.

Schedules: If you have programmed schedules for your system and a user code is entered outside of a schedule, the keypad displays INVALID TIME. This lets the user know that they are disarming outside of their authorized time.

Alarm Display: After disarming, the keypad displays any zones that tripped or any transmission problems that occurred during the armed period. All burglary zones are then disarmed and any bypassed zones are automatically reset.

Disarmed Message: The keypad displays ALL SYSTEM OFF after the system disarms.

Central Station Report: A report of the system disarming can be transmitted to the central station. This is optional and can be programmed for you at any time.

Disarming a Home/Sleep/Away or a Home/Sleep/Away with Guest System

1. During the entry delay time, the keypad displays ENTER CODE:. Enter your 4-digit user code.
2. The keypad then displays any alarms or communication problems that occurred during the armed period.
3. The keypad next displays ALL SYSTEM OFF to confirm the system is disarmed.

Disarming During an Alarm

1. While the alarm bell or siren sounds, enter your user code to silence the alarm. The keypad tone silences as soon as the first key is pressed.

For a burglary alarm, the keypad displays CANCEL VERIFY.

This allows you to investigate the alarm prior to disarming the system. This display remains on the keypad until a selection is made, the Back Arrow is pressed, or the internal system bell cutoff timer expires.

2. If a valid alarm has not occurred, select CANCEL to disarm the system and cancel the alarm.

The keypad next displays ALL SYSTEM OFF to confirm the system is disarmed.

OR

If the alarm is valid, select VERIFY to send a verify message to the Central Station.

Extending Schedules

Depending on your system programming, when the open schedule ends, you can extend the schedule to a later time. The keypad buzzer sounds and the keypad displays “area name” and LATE or CLOSING TIME!. This reminds users still on the premises to arm the system or extend the schedule.

To extend the system schedule:

1. Press any Select key. The keypad displays ENTER CODE: - .
2. Enter your code and press COMMAND or present your access card to a valid reader.
3. The keypad then displays 2HR 4HR 6HR 8HR. Select the number of hours to extend the schedule.

Note: If the system is not armed by the scheduled closing time, a Late to Close report is sent to the central station. If the schedule is extended, a Schedule Change report may be sent to the central station.

For information about extending a schedule before the scheduled closing time is reached, see Extending Schedules (EXT) in the User Menu portion of this guide.

Keypad Shortcut Keys

Your LCD keypad provides one-button shortcut keys. Holding down a keypad button for two seconds until the tone re-sounds allows you to arm, monitor, or reset your system. These options can still be accessed through the User Menu if desired.

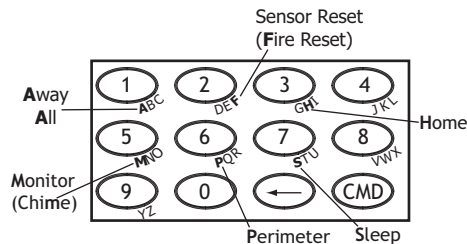

Keypad Shortcut Keys

Keypad Key

Press Key 1

Arming System Operation

Arm Away for Home/Sleep/Away systems

Arm Away for Home/Sleep/Away with Guest systems

Arm All for All/Perimeter systems

Press Key 2

Sensor (Fire) Reset on all systems

Press Key 3

Arm Home for Home/Sleep/Away systems

Arm Home for Home/Sleep/Away with Guest systems

Press Key 5

Monitor (Chime) on all systems

Press Key 6

Arm Perimeter for All/Perimeter systems

Press Key 7

Arm Sleep for Home/Sleep/Away systems

Arm Sleep for Home/Sleep/Away with Guest system

Arming Function

System Operation: Home/Sleep/Away, Home/Sleep/Away with Guest, or All/Perimeter.

You can use the Arming shortcut keys, 1, 3, 6, and 7 when the system is disarmed. You may be prompted to enter your user code.

If any zones are faulted, select force arm or bypass. Refer to the Arming Section for detailed arming operation.

Home/Sleep/Away and Home/Sleep/Away with Guest Arming

Arm Home – Press 3 for 2 seconds to arm the perimeter.

Arm Sleep – Press 7 for 2 seconds to arm the perimeter and interior areas and leave the bedroom area off.

Arm Away – Press 1 for 2 seconds.

All/Perimeter Arming

Arm Perimeter – Press 6 for 2 seconds.

Arm All– Press 1 for 2 seconds.

Sensor (Fire) Reset Function

System Operation: Area, Home/Sleep/Away, Home/Sleep/Away with Guest, or All/Perimeter.

You can use the Sensor (Fire) Reset, shortcut key 2, when the system is armed or disarmed. When pressed, detectors that have latched due to an alarm condition are returned to normal function. The keypad displays SENSORS ON and SENSORS OFF to acknowledge the shortcut key press.

Note: You may be prompted to enter your User Code.

Monitor (Chime) Function

System Operation: Area, Home/Sleep/Away, Home/Sleep/Away with Guest, or All/Perimeter.

You can use the Monitor (Chime), shortcut key 5, when the system is disarmed. When pressed, the Zone Monitor operation is initiated. As needed, refer to the Zone Monitor section. The keypad displays MONITOR ON and chimes or displays MONITOR OFF and no tone is sounded.

Note: The Monitor (Chime) shortcut key applies to all Exit zones in an Area system and to all zones assigned to the perimeter in a Home/Sleep/Away, Home/Sleep/Away with Guest, or All/Perimeter system.

User Menu

Many system features are programmed into a User Menu that you can access from any keypad. The menu requires you to enter your user code and then it only shows those functions to which you have access.

Accessing the User Menu

1. Press the COMMAND key, if the multi-language option is enabled, the available languages display. Select the language to use for text display.
2. Press the COMMAND key until MENU? NO YES displays.
3. Select YES. The keypad displays ENTER CODE: -. Enter your user code and press COMMAND. You can now scroll down through the list of system features available to you.

User Menu Options

The list below shows the User Menu options in order:

Menu Option	Description
ALARM SILENCE	Silences an alarm bell or siren.
SENSOR RESET	Resets smoke or glassbreak detectors that have latched due to an alarm condition.
DOOR ACCESS	Momentarily opens the keypad door lock relay.
ARMED AREAS	Displays the name of any areas in the system that are currently in the armed state.
OUTPUTS ON/OFF	Allows you to turn on or off any of the outputs described in the System Setup section of this guide.
ZONE STATUS	Allows you to see if a zone is either armed, bypassed, in alarm, open, or shorted.

BYPASS ZONES	Allows you to Bypass a zone or reset an already bypassed zone.
ZONE MONITOR	Allows you to add or remove a zone from the monitor mode.
SYSTEM STATUS	Displays the current condition of the system AC power, backup battery, and optional panel tamper.
SYSTEM TEST	Tests the system siren, communication to the central station, and backup battery on all XR500 Series and XR100 Series panels. XR500N or XR500E panels allow additional panic zone testing.
USER PROFILES	Allows you to add, delete, or change user profiles.
USER CODES	Allows you to add, delete, or change user codes.
SCHEDULES	Allows you to add, remove, or change system schedules.
TIME	Allows you to change the Day, Date, or Time that is currently programmed in the system.
DISPLAY EVENTS	Allows you to view or print the last 10,000 door accesses or 2,000 system events that occurred on your system.
SERVICE REQUEST	Allows you to send a message to the Central Station requesting service on the alarm system.
FIRE DRILL	Allows you to test the system fire bells.

Alarm Silence

Silences the alarm bells or sirens during an alarm.

Alarm Silence allows you to turn off the alarm bells and sirens connected to your system during an alarm. Using Alarm Silence does NOT stop an alarm report from being sent to the central station and does not reset any alarmed devices. Use the Sensor Reset function to reset devices such as smoke detectors that have latched in alarm.

Note: The keypad tone silences as soon as the first user code digit key is pressed. You can silence the alarm by entering your user code or by presenting your card to a reader during the Status List display. If using a card, areas assigned to your code are disarmed and door access occurs.

Using the Alarm Silence Function

1. Access the User Menu.
2. The keypad displays ALARM SILENCE?.
3. Press any Select key to silence the bells and exit the User Menu.

Sensor Reset

Resets smoke or glassbreak detectors. Also clears Fire/Supervisory alarm, trouble displays or low battery displays on systems using wireless sensors.

Sensor Reset is used to reset smoke and glassbreak detectors after they have tripped. Once these detectors trip, they must be reset before they can detect any additional alarm conditions. When you select Sensor Reset, power to the detectors is temporarily removed by the system allowing them to reset.

Make sure all smoke is cleared from around the area of the smoke detectors before performing a Sensor Reset to prevent the alarm from occurring again.

Sensor (Fire) Reset Shortcut Key

All Systems – Press 2 for 2 seconds, then enter your user code if required, to reset the system.

Resetting the Sensors

1. Access the User Menu.
2. Press COMMAND until SENSOR RESET displays.
3. The keypad displays SENSORS OFF followed by SENSORS ON.
4. The keypad automatically exits the User Menu.

Door Access

Operates an electric door strike from the keypad.

Note: The door strike function is not available on Clear Touch™ keypads.

Door Access is used to operate the door strike relay that is built into some keypads. Power for the door strike is connected to the keypad relay and can be interrupted by using the Door Access function.

When Status List displays, you can operate Door Access by simply entering your user code and pressing COMMAND. See Easy Entry™ User's Guide in Appendix E. If you are using a keypad that has a built-in card reader, you may simply present your card to be allowed Door Access.

Note: Your system may be pre-programmed at installation to transmit a door access report to the central station.

Using the Door Access

1. Access the User Menu.
2. Press COMMAND until DOOR ACCESS? displays.
3. Press any Select key. The door strike relay turns on momentarily.
4. The keypad returns to the Status List display.

Armed Areas Display

Displays all armed area names in the system.

The Armed Areas display lists all of the names of the armed areas in your system at the keypads.

Using the Armed Areas Function

1. Access the User Menu.
2. Press COMMAND until ARMED AREAS? displays.
3. Press any Select key. The keypad displays the first armed area name. To scroll through the list of armed area names, press the COMMAND key.
4. If there are no armed areas, the keypad displays NONE.

Outputs On Off

Allows you to manually turn the system or door access relay outputs ON and OFF.

This function is used to individually turn your system relay and access door outputs ON and OFF. Your system may use these outputs to control door access, interior and exterior lighting, heating, air conditioning, or other appliances.

The names and numbers of the relays connected to your system are located in the System Setup section of this guide.

Outputs can be turned ON or OFF regardless of the output settings in Schedules.

Your system may be programmed to require that your user code profile have access to areas assigned to the keypad. INVALID AREA displays when your user code does not have access to the keypad's areas and the output does not turn on.

Under certain conditions, some outputs cannot be turned on. If you select a restricted output, the keypad displays CANNOT TURN ON.

Turning the Outputs ON and OFF

1. Access the User Menu.
2. Press COMMAND until OUTPUTS ON/OFF? displays.
3. Press any Select key to display OUTPUTS DOOR.
4. Select OUTPUTS or DOOR for the type of output you want to turn ON or OFF.
5. Enter the output number you want to turn ON or OFF. The output number displays.
6. With the output number displayed, select ON or OFF. The output then turns ON or OFF depending on your selection, and remains in that state until you change it. The keypad displays the first 12 characters of the output or door name followed by either ON or OFF for four seconds to provide visual verification of the action. Press the COMMAND key to end the four second display.
7. The system automatically returns to the output or door option and a new output can be selected to turn ON or OFF. Refer back to step 4.
8. Press the Back Arrow key to exit the User Menu.

Browser Feature

If you are unsure of the output number, refer to Appendix B at the back of this guide for a diagram showing you how to use the built-in Outputs ON/OFF browser.

Zone Status

Displays a list of armed, bypassed, or alarmed zones. Also allows you to check the status of individual zones. Zone Status can be used to give you a list of zones by category or display the current status of an individual zone number. The four categories are:

- Armed Zones - zones that are currently armed.
- Bypassed Zones - zones that are currently bypassed.
- Alarmed Zones - zones that have gone into alarm during the current or previous armed period.
- Number - enter the number of any zone to check its status.

Using the Zone Status Function

1. Access the User Menu.
2. Press COMMAND until ZONE STATUS? displays.
3. Press any Select key to display ARM BYPS ALR NBR.
4. Select ARM for a list of zones that are currently armed. You can scroll through the list by pressing the COMMAND key.
5. Select BYPS for a list of zones that are currently bypassed.
6. Select ALR for a list of zones that have gone into alarm during the current or previous armed period.
7. Press NBR and ZONE NO: - displays.
8. At the ZONE NO: - option, enter the zone number you want to check and press COMMAND. The zone number and name display followed by the zone status. For example, a zone status for zone 1 might be BACK DOOR - OKAY.

Below is a list of the zone status displays:

-OKAY = the zone is in a normal condition

-BYPAS = the zone is bypassed

-BAD = the zone is in a bad or faulted condition

9. After displaying the zone status, ZONE: - returns for you to enter another zone number.

Browser Feature

If you are unsure of the zone number or description, refer to Appendix B at the back of this guide for a diagram showing you how to use the built-in Zone Status browser.

Bypass Zones

Allows you to bypass a zone prior to arming.

Bypassing is usually done when a zone cannot be restored to normal. A significant benefit of bypassing a zone is to allow a zone in a faulted or bad condition to be bypassed so arming can occur. The faulted zone can be serviced the next day.

A zone can be bypassed only while it is disarmed. Fire, panic, emergency, and supervisory type zones are always armed, so they can never be manually bypassed.

Bypass Zones can also be used to reset a zone that has been bypassed and restore it back into the system.

When Bypass Zones is selected, a report can be transmitted to your central station.

During arming, when choosing to bypass a zone or device, there **may** be a pre-programmed maximum number of zones (up to 8) that can be bypassed in an area. This limit is programmed at installation.

Using the Bypass Zones Function

1. Access the User Menu.
2. Press COMMAND until BYPASS ZONES? displays.
3. Press any Select key. The keypad displays ZONE: - RST BYPS.
4. To Bypass a zone, enter the zone number and select BYPS. The zone number automatically disappears and a new zone number can be entered. Refer back to step 3.
5. To Reset a zone, enter the zone number and select RST.

Browser Feature

If you are unsure of the zone number or description, refer to Appendix B at the back of this guide for a diagram showing you how to use the built-in Bypass Zones browser.

Zone Monitor

Allows the system to monitor selected disarmed zones (doors, windows, or motion detectors) and display their name at the keypad as they are faulted. This feature could be used to monitor an access door.

Zone Monitor works with any disarmed zone and also sounds the keypad monitor tone when the zone faults. The zone name displays at all keypads designated for the area in your system.

You can place any combination of disarmed zones in Zone Monitor but only the most recent zone faulted displays. The displayed zone name clears automatically after a short time or when the zone is armed.

Monitor (Chime) Shortcut Key

All Systems — Press 5 for 2 seconds when the system is disarmed. This initiates the Zone Monitor operation for all Exit zones in an Area system or all zones assigned to the perimeter in a Home/Sleep/Away, Home/Sleep/Away with Guest, or All/Perimeter system. The keypad displays MONITOR ON and chimes or displays MONITOR OFF and no tone is sounded.

Testing your system's burglary protection

After using the System Test function, place all zones in Zone Monitor. Starting at the front door, go around and open and then close each door and window. You should hear the keypad beep each time. The keypad also displays the name of each zone as its device is opened.

Once the protected doors and windows test is complete, walk in front of each motion detector. The keypad should beep to confirm the zone has tripped. If at any time during your weekly testing a device does not cause the keypad to beep, call the service department for assistance.

Using the Zone Monitor Function

1. Access the User Menu.
2. Press COMMAND until ZONE MONITOR? displays.
3. Press any Select key. The keypad displays ALL NBR or PERIM ALL NBR.
4. Select PERIM to place all disarmed perimeter zones into Zone Monitor.
 - 4a. The keypad displays ALL? ADD RMV.
 - 4b. Select ADD to add all disarmed zones to Zone Monitor.
 - 4c. Select RMV to remove all disarmed zones.
5. Select ALL to place all disarmed zones into Zone Monitor.
 - 5a. The keypad displays ALL? ADD RMV.
 - 5b. Select ADD to add all disarmed zones to Zone Monitor.
 - 5c. Select RMV to remove all disarmed zones.
6. Select NBR to enter a specific zone number for zone monitor.
7. If you select NBR, the keypad displays ZONE: - ADD RMV.
 - 7a. Enter any zone number and select ADD to add this zone.
 - 7b. Enter any zone number and select RMV to remove this zone.
8. The zone number automatically disappears. You can then enter a new zone number and repeat step 7a or 7b.

Browser Feature

If you are unsure of the zone number or description, refer to Appendix B at the back of this guide for a diagram showing you how to use the built-in Zone Monitor browser.

System Status

Displays the current condition of internal system hardware.

System Status shows the panel condition of AC power, battery power, and optional panel tamper. When System Status is selected, each monitor displays followed by OKAY or TRBL (Trouble) to indicate the current condition.

Using the System Status Function

1. Access the User Menu.
2. Press COMMAND until SYSTEM STATUS? displays.
3. Press any Select key. The display starts listing each system monitor and status.

For example: AC POWER - OKAY

Below are the System Monitor displays:

Keypad Display	What it monitors
AC POWER	AC power
BATTERY	Battery power
TAMPER	Panel box tamper

These are followed by either OKAY or TRBL (trouble).

If TRBL displays, call the service department for assistance.

4. The system then displays its firmware version, the panel mode, and then exits the User Menu.

For example: VER_118_1/20/07 MODEL XR500

System Test

System Test is used to test the battery, alarm bell or siren, and communication to a central station. The System Test function begins automatically as soon as you select it.

Note: If an area is in an armed state, the system test will not operate.

Using the System Test Function

1. Access the User Menu.
2. Press COMMAND until SYSTEM TEST? displays.
3. The keypad displays SYSTEM PANICS. Select SYSTEM.
3. The System Test begins automatically and the keypad displays the following messages in this order:
 - 1) **BELL SOUNDING** during a two second bell test
 - 2) **KEYPAD SOUNDING** all keypads assigned to the same area sound their burglary alarm tone for two (2) seconds during the keypad sounder test
 - 3) **BATTERY - OKAY** or **BATTERY - TRBL** to indicate the battery condition
 - 4)* **TRANSMIT TEST NO: 1** during the transmit test
 - 5) **TRANSMIT OKAY** or **TRANSMIT FAILED** to show the results of the transmit test
 - 6) **TEST END** to indicate the System Test is complete.
 - 7) You can press the Back Arrow key to end the transmit test.

* The transmit test does not occur on local systems.

Using the Panic Zone Test (XR500N/E Only)

1. Access the User Menu.
2. Press COMMAND until SYSTEM TEST? displays.
3. Press any Select key. The keypad displays SYSTEM PANICS.
4. Select PANICS.
5. The Panic Zone Test begins automatically and the keypad displays TRIPS: END.

During the Panic Zone Test, trip each panic zone (or button) by pressing and holding the panic for 1 to 2 seconds.

Note: You do NOT have to hold the panic for 2 seconds in normal mode. The Panic Zone Test takes additional time to report when the system is in test mode.

Each time you trip a panic zone, the display number increments and the keypad buzzer sounds for two seconds.

The number of panic zones tripped constantly displays until the test ends or no panic zone activity has occurred for 20 minutes.

6. Select END to stop the Panic Zone Test.
7. PANIC TEST OKAY displays when the Panic Zone Test is completed and all zones tested OK.
8. When the Panic Zone Test ends and a zone failed (did not trip) during the test, the keypad displays the zone name and number and the buzzer sounds for one second. Press the COMMAND key to display the next failed zone.

Note: During the Panic Zone Test, any zones that fail are not sent to the receiver unless pre-programmed at installation to be sent.

Note: Your system may be programmed to limit the Panic Zone Test to only be performed during the Area 32, Shift 4 schedule.

User Profiles

Add, delete, or change User Profiles, that define the authority of each user code in the system. Several characteristics define the authority of each User Profile within the system. Always make sure that at least one administrator in your system has a profile with all authorities and all areas.

In All/Perimeter or Home/Sleep/Away operation, User Profiles will not display in the User Menu. When adding User Codes, use the default profiles 1 through 10. Refer to the User Profiles Chart.

In Home/Sleep/Away with Guest operation, the User Profiles option does not display in the User Menu but when adding User Codes, enter a profile number 1 through 9 for the main house system, profiles 11-19 for the Guest 1 house system, and profiles 21-29 for the Guest 2 house system (XR500 only). Profiles 2-9 will default to have Arming/Disarming for all eight areas, while profiles 12-19 and 22-29 only have Arm/Disarm assigned to Guest 1 and Guest 2 respectively. Profiles 1, 11, and 21 do not have any Arming/Disarming authority assigned. Refer to the User Profiles Chart.

Profile Number - Each profile may be assigned a unique number from 1 to 99.

Profile Name - Each profile may be assigned a 32-character name. The Profile Number is the default name.

Area Number - Each profile may be assigned specific areas of the system for arming and disarming. When profiles 1 to 98 are created, NO areas are assigned by default. The default for profile 99 is ALL areas assigned. Profile 99 is predefined in the system by the factory. In an XR500 Series system you can assign areas 1 to 32. In an XR100 Series panel you can assign areas 1 to 8.

Access Area Number - Each profile may be assigned door access area assignments. Default for profile 1 to 98 is NO areas assigned. Default for profile 99 is ALL areas assigned. Profile 99 is predefined at the factory.

Output Group Assignment - Each profile may be assigned an output group number from 1 to 10. Default for profile 1 to 98 is NO output group assigned. Default for profile 99 is output group **10**. Your system may be programmed to turn on an output group at certain keypads when door access occurs.

User Menu Assignments - Each user profile may have any of the menus assigned to it as shown in the User Profile Record. The User Profile Record lists the user menu profile assignments and the system functions users are allowed to access based on the profile numbers assigned to their codes.

Adding User Profiles

1. Access the User Menu. Press COMMAND to USER PROFILES?.
2. Press any Select key. The keypad displays ADD DEL CHG. Select ADD to add a new user profile.
3. At the PROFILE NO: - option, enter an unused profile number and press COMMAND. The display changes to PROFILE NAME.
4. Press any Select key. Enter a profile name of up to 32 characters. Press COMMAND. See Appendix C.
5. At the ARM/DIS AREAS: option, select the area numbers for arming and disarming assigned to this profile.
6. The keypad displays ACCESS AREAS: . Select the area numbers assignment to allow door access for this profile. Press the COMMAND key.
7. The keypad displays OUTPUT GROUP: -. Enter the number for the Output Group assigned to this profile. Press the COMMAND key.
8. The keypad displays each of the menus as shown in the Profile Table for you to enable for this profile number. Select YES or NO and press the COMMAND key to advance to the next menu Selection.
9. When you have completed selecting all User Profile menu assignments, the keypad displays the PROFILE ## ADDED message for 4 seconds.

Browser Feature

Refer to Appendix B in this guide for a diagram showing you how to use the Add User Profiles browser.

Changing User Profiles

1. Access the User Menu.
2. Press COMMAND until USER PROFILES? displays.
3. Press any Select key. The keypad displays ADD DEL CHG.
4. Select CHG to change a user profile.
5. At the PROFILE NO: - option, enter a profile number and press COMMAND. The display changes to PROFILE NAME.
Note: The panel's authority check determines whether your User Profile is authorized to change another profile. The message NO AUTHORITY appears if you are not authorized to change the profile.
6. Press any Select key to display -. Enter a profile name of up to 32 characters. The default Profile Name uses the Profile Number. Enter the name and press COMMAND.
7. At the ARM/DIS AREAS: option, enter the area numbers for arming and disarming assigned to this profile.
8. The keypad displays ACCESS AREAS: . Enter the area numbers assignment to allow door access for this profile. Press the COMMAND key.
9. The keypad displays OUTPUT GROUP: -. Enter the number for the Output Group assigned to this profile. Press the COMMAND key.
10. The keypad displays each of the menus as shown in the Profile Table. You then enable or disable the menu function for this profile number. Select YES or NO and press the COMMAND key to advance to the next menu selection.
11. When you complete Selecting all User Profile menu assignments, the keypad displays the PROFILE CHNGD message for 4 seconds, indicating the profile is changed.

Browser Feature

Refer to Appendix B in this guide for a diagram showing you how to use the Change User Profiles browser.

Deleting User Profiles

1. Access the User Menu.
2. Press COMMAND until USER PROFILES? displays.
3. Press any Select key. The keypad displays ADD DEL CHG.
4. Select DEL to delete a user profile.
5. At the PROFILE NO: - option, enter a profile number and press COMMAND. The display changes to DELTD.

Note: User codes assigned to deleted profiles will not function.

Browser Feature

Refer to Appendix B in this guide for a diagram showing you how to use the Delete User Profiles browser.

TEMP CODE

When you select YES for this menu option, and this profile is assigned to a user code (see next section), the keypad displays TEMP EXPIRE DATE:. Enter the ending date for the profile to expire. Default is seven days from today. The system deletes Temp users at 12:00 AM on the last date.

ANTI PASS NO

Anti-passback requires that you properly exit (egress) an area previously accessed. If you fail to exit through the proper location you cannot access it until you properly exit. Default is No. See Failed to Exit (Anti-Passback) for more information.

EASY ARM/DISARM?

When entering your code, Easy Arm/Disarm allows you to automatically arm or disarm all areas that are assigned to your code. The ALL NO YES? option does not display when this option is enabled.

SHIFT TIME ACCESS: 1 2 3 4 ANYTIME

This menu option defines the time schedules that the User Code operates for door access and disarming. Selecting 1, 2, 3, and/or 4 indicates operation during the S1-S4 shift schedules. Selecting ANYTIME from the menu indicates the code operates any time, regardless of schedules. An asterisk displays next to the shift or Anytime choice. You may select all shift schedules for one user. Menu access is not affected by this option. An UNAUTHORIZED ENTRY message is sent to the central station if disarming occurs outside the open/close schedule.

RE ARM DELAY

RE ARM DELAY allows the entry of 0 to 250 minutes to be used to delay automatic rearming when the user disarms an area outside of schedule. If zero is selected, the rearming occurs based on permanent programming in the panel. If another user enters a valid user code or credential after the RE ARM DELAY countdown has started, and their user profile RE ARM DELAY is greater, then the RE ARM DELAY countdown starts over with the new time.

RE ARM DELAY is also used to delay a late to close message to the central station when the panel does not use automatic arming.

If the user has Extend Schedule authority, 2HR 4HR 6HR 8HR displays at disarming. If the user does not make a choice, the RE ARM DELAY is used to extend the schedule.

Application example: An exit door near the trash is scheduled to be armed at all times. When the custodian needs to remove trash, program 10 minutes for the activity. Or, an overhead door only requires access when a delivery is made. Program up to 250 minutes to allow the loading dock supervisor to load or unload a semi-truck.

USE SECONDARY LANGUAGE

This options allows you to set the programmed secondary user language to display when the Easy Arm/Disarm option is enabled and the user presents their credential or enters their user code at the Status List.

User Profiles Chart

Note: For All/Perimeter or Home/Sleep/Away systems use the default profiles 1 through 10. For Home/Sleep/Away with Guest systems use the default profiles 1 through 9 for the main house system, default profiles 12-19 for the Guest 1 house system, and default profiles 22-29 for the Guest 2 house system. Profiles 12-19 and 22-29 default to the same privileges as profiles 2-9. For example, profile 13 and 23 have the same privileges as profile 3.

Menu Display			Privilege	Predefined Profile Number											
				1	2	3	4	5	6	7	8	9	10	11-98	99
ARM	NO	YES	Arm	No	Yes	Yes	Yes	Yes	Yes	Yes	Yes	Yes	No	No	Yes
DISARM	NO	YES	Disarm	No	Yes	Yes	Yes	Yes	Yes	Yes	Yes	Yes	No	No	Yes
ALM SLNC	NO	YES	Alarm Silence	No	Yes	Yes	Yes	Yes	Yes	Yes	Yes	Yes	No	No	Yes
SNSR RST	NO	YES	Sensor Reset	Yes	Yes	Yes	Yes	Yes	Yes	Yes	Yes	Yes	No	No	Yes
DOOR ACS	NO	YES	Door Access	Yes	Yes	Yes	Yes	Yes	Yes	Yes	Yes	Yes	Yes	No	Yes
ARM AREA	NO	YES	Armed Areas	Yes	Yes	Yes	Yes	Yes	Yes	Yes	Yes	Yes	No	No	Yes
OUTPUTS	NO	YES	Outputs ON/OFF	No	No	No	No	Yes	Yes	Yes	Yes	Yes	No	No	Yes
ZN STAT	NO	YES	Zone Status	Yes	Yes	Yes	Yes	Yes	Yes	Yes	Yes	Yes	No	No	Yes
BYPAS ZN	NO	YES	Bypass Zones	No	No	No	No	No	Yes	Yes	Yes	Yes	No	No	Yes
ZONE MON	NO	YES	Zone Monitor	No	No	No	Yes	Yes	Yes	Yes	Yes	Yes	No	No	Yes
SYS STAT	NO	YES	System Status	Yes	Yes	Yes	Yes	Yes	Yes	Yes	Yes	Yes	No	No	Yes
SYS TEST	NO	YES	System Test	No	No	No	Yes	Yes	Yes	Yes	Yes	Yes	No	No	Yes
PROFILES	NO	YES	User Profiles	No	No	No	No	No	No	No	No	Yes	No	No	Yes
USR CODE	NO	YES	User Codes	No	No	No	No	No	No	No	No	Yes	No	No	Yes
SCHEDULES	NO	YES	Schedules	No	No	No	No	No	No	Yes	Yes	Yes	No	No	Yes
TIME	NO	YES	Time	No	No	No	No	No	No	No	Yes	Yes	No	No	Yes
DIS EVNT	NO	YES	Display Events	Yes	Yes	Yes	Yes	Yes	Yes	Yes	Yes	Yes	No	No	Yes
SERV REQ	NO	YES	Service Request	No	No	No	No	No	No	No	Yes	Yes	No	No	Yes
FIRE DRILL	NO	YES	Fire Drill	No	No	No	No	No	No	No	Yes	Yes	No	No	Yes
EXTEND	NO	YES	Extend Schedules	No	No	No	No	No	Yes	Yes	Yes	Yes	No	No	Yes
TEMP CODE	NO	YES	Temp User Code	No	No	No	No	No	No	No	No	No	No	No	No
ANTI PASS	NO	YES	Anti-Passback	No	No	No	No	No	No	No	No	No	No	No	No
EASY ARM/DISARM	NO	YES	Arm/Disarm	No	No	No	No	No	No	No	No	No	No	No	No
1234 ANYTIME	ANYTIME		Shift Time Access	1234	1234	ANYTIME	ANYTIME	ANYTIME	ANYTIME	ANYTIME	ANYTIME	ANYTIME	ANYTIME	ANYTIME	ANYTIME
RE ARM DLY	0 – 250		Re-Arm Delay	No	No	No	No	No	No	Yes	Yes	Yes	No	No	Yes
SEC LANGUAGE	NO	YES	Preferred Language	No	No	No	No	No	No	No	No	No	No	No	No

User Codes

This option allows you to add, delete, or change a user code. You may also assign specific User Profiles to individual users.

1234	=	User Number
34812	=	User Code
89456	=	PIN (XR500E Code Plus PIN systems only)
John Smith	=	User Name
7	=	Profile

User Number - Every user is numbered 1 through 9999. This number identifies the user to the system and is transmitted to the central station when the user arms or disarms areas.

User Code - Each user also has a 3- to 6-digit number to 999999, to enter into the keypad when arming or disarming the system. Only 4-digit user codes can be assigned to All/Perimeter, Home/Sleep/Away, or Home/Sleep/Away with Guest system users.

Note: A User Code cannot begin with zero and 3-digit codes cannot begin with 98.

For UL installations, avoid using repetitive (111) or sequential (123) codes.

PIN - In an XR500E Card Plus PIN system, each user is assigned a unique PIN (up to 6 digits) to enter into the keypad after presenting their card/proximity credential to the reader when accessing system functions.

User Names - Each code may also be programmed with the user name. You may enter up to 32 characters for the name. As needed, refer to Appendix C for Entering User Names information.

User Profile - The user is also assigned a Profile (1 to 99) by the person administrating the system. The profile number determines the areas and functions the user can access.

Adding User Codes

1. Access the User Menu.
2. Press COMMAND until USER CODES? displays.
3. Press any Select key. The keypad displays ADD DEL CHG BAT.
4. Select ADD or BAT (Batch) to add a new user code.
5. At the USER NUMBER: - option, enter a user number and press COMMAND. The display changes to USER CODE: - .

Note: Do NOT program a code for user number 1 unless you intend to use the Ambush function. See Ambush.

6. Enter a user code of 3 to 6 digits and press COMMAND. The user enters this number to arm, disarm, etc. If using access cards, present the card instead of entering a code. After entering the code the keypad displays USER NUMBER ### as the user name.
7. A 32-character name may be entered to identify the user. Press any top row key to clear the current name. You may then enter the new name. After entering the name press COMMAND. See Entering Names in Appendix C.
8. The display changes to PROFILE NO: -. Select the profile number to assign a set of authorized functions to the user code as outlined in the Profile Table on the previous page.

Note: On All/Perimeter or Home/Sleep/Away systems use the default profiles 1 through 10. For Home/Sleep/Away with Guest systems use the default profiles 2 through 9 for the main house system, default profiles 12-19 for the Guest 1 house system, and default profiles 22-29 for the Guest 2 house system.

- At the PROFILE NO: - display, enter a profile number from 1 to 99, and press COMMAND. The display shows USER # ADDED.

If BAT (Batch) was chosen in step 4 instead of ADD, the next available user number is automatically selected and only steps 6 and 7 repeat. The User Profile assignment is automatically selected for the next user based on the previous user entered. This batch entry method speeds up user entry in large systems.

Browser Feature

Refer to Appendix B at the back of this guide for a diagram showing you how to use the Add User Codes browser.

Changing User Codes

To change a user code, you must have a user code with a profile that has user code authority.

- Access the User Menu.
- Press the COMMAND key until USER CODES? displays.
- Press any Select key. The keypad displays ADD DEL CHG BAT.
- Select CHG to change a user code.
- At the USER NUMBER: - option, enter the user number to change and press COMMAND.

Refer to the System Setup section for the number of user codes available for your system.

- The display changes to USER CODE: * * * * *. Press any Select key and enter the new user code. Press COMMAND.
- The display then shows the current user name. Press any top row key to clear. See Entering Names in Appendix C to enter a new name.

Note: Changing a user code does not change the user number.

- The display changes to PROFILE NO: -. Select the profile number to assign a set of authorized functions to the user code as outlined in the Users Profile Chart.
- After entering the profile number, the keypad displays USER # CHANGED for five seconds followed by USER NUMBER: -. This display allows you to enter another user number to change. Press the Back Arrow key twice to exit the User Menu.

Changing Own User Code

- Access the User Menu.
- Press the COMMAND key until USER CODES? displays. Press any Select key.
- The display changes to USER CODE: * * * * *. Press any Select key.
- Type your new user code. Press Command.

Browser Feature

Refer to Appendix B for diagrams showing you how to use the Change User Codes browser.

Deleting User Codes

- Access the User Menu.
- Press COMMAND until USER CODES? displays.
- Press any Select key. The keypad displays ADD DEL CHG BAT.
- Select DEL to delete a user code from the system. To delete a user code, you must have a user code with a profile that has user code authority.

Note: Your system must have at least one user with user code authority in order to be able to add or delete user codes. Be careful not to delete all users with user code authority from your system. Also, the user code used to enter the user menu to delete codes cannot be deleted. In other words, you can not delete yourself.

5. At the USER NUMBER: - option, enter the user number you want to delete and press COMMAND. The display changes to USER # DELETED.
6. The display then changes back to USER NUMBER: - allowing you to delete another user. Press the Back Arrow key twice to exit the User Menu.

Browser Feature

Refer to Appendix B at the back of this guide for a diagram showing you how to use the Delete User Codes browser.

Forgive Failure to Exit

Failure to Exit is an Anti-passback violation in which a user assigned with anti-passback has attempted to re-enter an area that they did not exit through.

Forgive Failure to Exit removes the anti-passback violation. See Failed to Exit (Anti-Passback) for more information.

1. After the USER CODES? menu is accessed and ADD DEL CHG BAT displays, press COMMAND.
2. Select FRGV to forgive the Failure to Exit and press COMMAND.
3. At the USER NUMBER:- option, enter the user number to be forgiven and press COMMAND. The User Code Browser described in Appendix B can help find the appropriate user by name if you do not know the number.
To clear the FAILURE TO EXIT (Anti-passback) violation for all users, enter 000 at the USER NUMBER:- option.
4. The keypad displays USER XXXX FORGVN to confirm, then returns to step 3 for the next user. Press the Back Arrow key to exit this menu.

Ambush Code

Your system may be programmed to allow user number 1 to be used as an Ambush code. This Ambush code functions identically to a standard code with the exception that it sends a silent alarm to the central station. This silent alarm alerts the operator to a duress situation at the premises and prompts immediate notification of authorities.

Refer to the System Setup section of this guide to see if your system is programmed for Ambush. If so, do NOT program a code for user number 1 unless you intend to use the Ambush function.

Schedules

Schedules are ideal for individual area auto arming and disarming and for creating Opening/Closing windows during which users can access the building or disarm the system. Having separate schedules allows you to create Opening/Closing windows for each day. One could be for normal business activity and another could be for cleaning crews or a second shift. Once programmed, these schedules operate continually until changed.

The Schedules function allows you to program into the system the times at which you normally turn your burglary protection on and off each day of the week. Your system may be pre-programmed at installation to allow automatic arming and disarming. When pre-programmed, you can enter a schedule for the arming and disarming times.

If your system does not use automatic arming, you can use the Closing Check/Extend feature with Schedules to help ensure your system is armed manually at a specific time. This option sounds the keypad buzzer and displays CLOSING TIME! or AREA LATE! when a schedule expires. This reminds users still on the premises to arm the system or extend the schedule to a later time.

Your system provides you with five different types of schedules:

Shift (S1, S2, S3, S4) allow you to set access and disarm schedules that occur at the same time each day until you change them. Users are assigned to shifts using the ALLOW authority.

Output (OUT) schedules allow you to set the times when relay outputs or door strikes connected to your system turn ON and OFF automatically.

Door (DOOR) schedules allow you to set times when door strikes turn ON and OFF automatically.

Holiday (HOL) dates allow you to enter special dates that activate Holiday Schedules that supersede all other schedules.

Extend (EXT) schedules allow you to set a time for a one time extend of the currently running shift (S1 - S4) schedule.

Setting Shift (S1 S2 S3 S4) Schedules

1. Access the User Menu and press COMMAND until SCHEDULES? displays. Press any Select key.
2. The keypad displays S1 S2 S3 S4. Select the shift you want to program. This allows you to enter a schedule that remains in place until you change or delete it.
3. Your system may be programmed to allow four shift schedules per area, if so, AREA NO:- displays. Enter the area number that you want to assigning to this schedule. Press the COMMAND key to accept your Selection and continue setting schedules.
4. The keypad displays SUN MON TUE WED. Press the COMMAND key to display THU FRI SAT HOL. Select the day you want the schedule to begin. If you select HOL, go to Setting Holiday ABC Schedules for additional instructions.

Note: After Selecting the day of the week or holiday for the schedule to begin, the keypad displays any currently programmed Opening and Closing times previously set for that day. This feature allows you to review programmed schedules at any time.

A schedule entered in HOL (holiday) activates and overrides SUN MON TUE etc. schedules anytime a holiday date occurs.

- If Opening and Closing times display, the keypad then displays DELETE KEEP. Select DELETE to enter new times.
- The keypad then displays OPENING TIME? followed by the display MON - : AM PM. Enter the new opening time and select AM or PM.

Enter all schedule times using a 12 hour clock. For example, to enter 6 AM you would enter a 0 + 6 + 0 + 0 and select AM. For 11 PM you would enter a 1 + 1 + 0 + 0 and select PM.

The keypad then displays CLOSING TIME? followed by the display MON - : AM PM. Enter the new closing time and select AM or PM. Select whichever day displays, for example, MON, allows you to scroll through the days of the week and create a schedule window that spans multiple days.

Note: You must enter an Opening and Closing time or the system will not recognize the schedule.

The new schedule is now programmed into your system.

- The keypad goes back to the SUN MON TUE WED display allowing you to enter another schedule.
- To clear a schedule press DELETE and then AM when the opening time is requested.

Press the Back Arrow key to exit the User Menu.

Note: Your system may be programmed to limit the Panic Zone Test to only be performed during the Area 32, Shift 4 schedule.

Setting Output (OUT) and Door (DOOR) Schedules

The Schedules function allows you to set up to 100 different scheduled times for relay outputs and door access relays connected to your system to turn ON and OFF automatically. The maximum number of schedules that can be assigned per door access relay or relay output is 8.

- Access the User Menu.
- Press COMMAND until SCHEDULES? displays.
- After you have accessed the SCHEDULES? menu and the schedule options, S1 S2 S3 S4, display, press the COMMAND key once more and the display changes to OUT DOOR HOL EXT. Select OUT or DOOR.
- At the OUTPUT NO: - or DOOR NO: - display, enter the output or door number you want to program. Press the COMMAND key.

If adding a schedule and all 100 scheduled times are currently in use, OUT SCHEDULES FULL displays. You must then delete an existing schedule.

- The keypad displays SCHEDULE NO: -. Enter the schedule number (1 to 8) and press the COMMAND key.
- The keypad displays SUN MON TUE WED. Press the COMMAND key to display THU FRI SAT HOL.
- Select the day you want to program. If you select HOL go to Setting Holiday ABC Schedules for more information.

Note: After Selecting the day of the week for the schedule to occur, the keypad displays any currently programmed ON OFF times previously set for that day. This feature allows you to review programmed schedules at any time.

8. If ON OFF times display, the keypad then displays DELETE KEEP. Select DELETE to enter new times.
9. The keypad then displays ON TIME?. This is followed by the display - : AM PM.
Enter a new relay ON time and select AM or PM.
The display changes to OFF TIME?. This is followed by the display - : AM PM.
Enter a new OFF time for the relay.
Enter all schedule times using a 12 hour clock. For example, to enter 6 AM you would enter 0 + 6 + 0 + 0 and select AM. For 11 PM you would enter 1 + 1 + 0 + 0 and select PM.
10. The keypad returns to the day of the week display allowing you to enter another Output or Door schedule. To exit the user menu or to go back to the S1 S2 S3 S4 display, press the Back Arrow key.

Setting Holiday ABC Schedules for S1, S2, S3, S4, OUT, and DOOR Schedules

Three Holiday schedules are available for each shift (S1, S2, S3, S4), each output relay (OUT), each door access relay (DOOR), and through their respective menu options. This allows a shift, output, or door to have three different schedules for holidays. For example, Holiday Schedule A for those holidays when the building stays closed, Holiday Schedule B for a day that only opens for a morning, etc. Also, Holiday Schedules can be used to cross multiple days. These schedules become active and supersede the current day's schedule when a Holiday Date occurs. See Setting Holiday Dates (HOL).

1. After you have accessed the SCHEDULES? menu and the schedule options, S1 S2 S3 S4, display, press the COMMAND key until the display changes to SUN MON TUE WED. Press the COMMAND key again to display THU FRI SAT HOL.
2. Select HOL to program holiday schedules.
3. The keypad displays HOL: A B C . Select A to set the first of three holiday schedules.
4. The keypad displays A - : AM PM.

Note: After Selecting the schedule, the keypad displays any current times previously set for that holiday. This feature allows you to review the programmed times.

5. If times display, the keypad then displays DELETE KEEP. Select DELETE to enter new times.
6. The keypad then displays ON TIME? or OPENING TIME?. This is followed by the display - : AM PM.

Enter a new time and select AM or PM.

The display changes to OFF TIME? or CLOSING TIME?. This is followed by the display - : AM PM.

Enter a new time.

Enter all schedule times using a 12 hour clock. For example, to enter 6 AM you would enter 0 + 6 + 0 + 0 select AM. For 11 PM you would enter 1 + 1 + 0 + 0 and select PM.

7. The keypad returns to HOL: A B C allowing you to enter a B and/or C holiday schedule for the same Shift (S1, S2, S3, or S4), Output or Door. Go back to step 3 to add additional holiday schedules.

Setting Holiday Dates (HOL)

Setting Holiday Dates provides the system with dates in the year when the normal opening and closing schedules are not used and superseded by one of the Holiday Schedules A or B or C. When the panel determines that it is a holiday, the Holiday Schedule supersedes the current schedule for that day. Up to twenty different holiday dates can be entered.

1. After you access the SCHEDULES? menu and the schedule options, S1 S2 S3 S4, display, press the COMMAND key once more. The display changes to OUT DOOR HOL EXT. Select HOL to program Holiday dates.
2. The keypad display changes to HOL: xx mm/dd A. You can now enter the month and day for the first holiday. Select A to change to HOL B. Pressing again changes to HOL C. Example: July fourth would be entered by pressing the 0704 keys. The keypad displays HOL:1 07/04 B.
3. To step to the next holiday number, press COMMAND. To clear a holiday press any top row Select key when the appropriate holiday number displays. Press the Back Arrow key when HOL: 1 or the COMMAND key when HOL: 20 displays to exit the menu.

Note: The Holiday Dates entered indicate the days of the year when HOL schedules are used. For information on setting holiday schedules for Shift, Output, and Door, see Setting Holiday ABC Schedules.

Extending Schedules (EXT)

Extending schedules (EXT) allows the Closing Check operation to delay until the new closing time expires. This allows the current shift schedule to ignore its closing time and not send a LATE TO CLOSE message to the central station. This function is designed to allow workers to stay later and does not extend door access authority. The extended schedule erases when it expires.

1. After you access the SCHEDULES? menu and the schedule options, S1 S2 S3 S4, displays, press the COMMAND key once more. The display changes to OUT DOOR HOL EXT. Select EXT to program Extended Schedules.
2. The keypad displays - : AM PM. Enter a time to extend the current Closing Check open period. Press COMMAND to exit the menu.

A shift may be extended up to 23 hours and 59 minutes from the time the extend function is performed.

To extend the system schedule after the closing time is reached:

1. Press any Select key. The keypad displays ENTER CODE.
2. Enter your code and press COMMAND. The system schedule automatically extends one hour.
3. The keypad then displays -: AM PM. You can enter a time to extend the schedule for greater than one hour. Press AM or PM.

Note: If the system is not armed by the scheduled closing time, a Late to Close report is sent to the central station. If the schedule is extended, a Schedule Change report is sent to the central station.

Setting the Date and Time

Allows you to change the current date and time displayed on the keypad and used by the system.

Setting the System's Date and Time

1. Access the User Menu.
2. Press COMMAND until TIME? displays. Press any Select key.
3. The keypad displays the current day and time. Press the COMMAND key. The keypad displays the current date. Press the COMMAND key to make any changes.
4. The keypad displays TIME DAY DATE.
5. Select TIME to change the time. The keypad displays - : AM PM. Enter the current time and select AM or PM. The display changes back to TIME DAY DATE.
6. Select DAY to change the day of week. The keypad displays SUN MON TUE WED. Press the COMMAND key to display THU FRI SAT. Select the correct day. Use the Back Arrow key to toggle between the different day of the week displays.
7. Select DATE to change the date. The keypad displays:
MONTH:- Enter up to 2 digits for the month.
Press COMMAND.
DAY:- Enter up to 2 digits for the day.
Press COMMAND.
YEAR:- Enter up to 2 digits for the year.
Press COMMAND.

The display returns to the TIME DAY DATE display.

Press the Back Arrow key to exit the User Menu.

Display Events

Allows you to review up to 12,000 past door access and system events. There are six event types:

Zone Activity - Zone alarms, troubles, and restorals.

Opening and Closing - System arming and disarming.

User Code - Adding, deleting, and changing user codes.

Schedule Changes - Adding, deleting, and changing schedules.

Door Access - Each door access function used at a keypad.

Supervisory - Problems with system hardware components.

The system memory holds a maximum of 12,000 past events for 45 days. Any event older than 45 days automatically clears from the system memory. Also, once the full 12,000 events are stored, any new event causes the oldest event to be cleared. See Appendix A for Display Events.

Service Request

Your user code profile may be programmed for Service Request. This User Menu feature allows you to simply press any Select key when SERVICE REQUEST? displays and have the system automatically send a "Request for Service" message to the central station. The display changes momentarily to REQUEST MADE to confirm your request was sent.

Fire Drill

Fire Drill is used to test the fire bells or fire horns in your system. The Fire Drill test turns your system bell circuit on, but does not send a message to the central station.

Starting a Fire Drill test

1. Access the User Menu.
2. Press COMMAND until FIRE DRILL? displays. Press any Select key.
3. The keypad displays SURE? YES NO.
4. Select YES to start the Fire Drill test.

Ending a Fire Drill test

1. Enter your code at the keypad and press COMMAND to end the Fire Drill.
2. The Fire Drill test automatically ends with ALARM SILENCE or the programmed Bell Cutoff time.

System Setup

System Setup Record

This System Setup section allows you to track the current and future status of the programmable options on your system. If changes are made to the system, update the information contained on these pages.

XR500 System XR100 System

Your system operation configuration.

Area Home/Sleep/Away
 All/Perimeter Home/Sleep/Away with Guest

Your system is monitored by a central station.

Yes No

C/S Name: _____

Address: _____

City/State: _____

Emergency Phone: _____

Service Phone: _____

Service Manager: _____

Your system sends Opening and Closing reports.

Yes No

Your system sends Zone Bypass reports.

Yes No

Your system sends Ambush reports.

Yes No

Your XR500E system uses Card Plus PIN operation.

Yes No

System Setup

Keypad Record

Note: XR500 systems support 16 keypad devices. XR100 systems support 8 keypad devices.

Device #	Name	Areas
1 _____	_____	_____
2 _____	_____	_____
3 _____	_____	_____
4 _____	_____	_____
5 _____	_____	_____
6 _____	_____	_____
7 _____	_____	_____
8 _____	_____	_____
9 _____	_____	_____
10 _____	_____	_____
11 _____	_____	_____
12 _____	_____	_____
13 _____	_____	_____
14 _____	_____	_____
15 _____	_____	_____
16 _____	_____	_____

Which keypads display System Status?

- 1 2 3 4
 5 6 7 8
 9 10 11 12
 13 14 15 16 N/A

Which keypads display Armed Status?

- 1 2 3 4
 5 6 7 8
 9 10 11 12
 13 14 15 16 N/A

Which keypads provide Door Access reports?

- 1 2 3 4
 5 6 7 8
 9 10 11 12
 13 14 15 16 N/A

Key Fob Button Programming

Enter the user name assigned to each key fob and the button action programmed for each button in the table below. Refer to the Introduction and Appendix D for more information.

Key Fob User Name	Button	Programmed Action
	TOP	
	BTM	
	LFT	
	RGT	
	TOP	
	BTM	
	LFT	
	RGT	
	TOP	
	BTM	
	LFT	
	RGT	
	TOP	
	BTM	
	LFT	
	RGT	
	TOP	
	BTM	
	LFT	
	RGT	

Area Names and Numbers Record

XR500 systems may be divided into 32 separate areas. XR100 systems may be divided into 8 separate areas. All/Perimeter systems are divided into two separate areas. Home/Sleep/Away and Home/Sleep/Away with Guest systems are divided into two or three separate areas. Each area can have a name or description that displays at the keypad. This can help you easily track events when and wherever they occur in your system.

Area Name

1	_____
2	_____
3	_____
4	_____
5	_____
6	_____
7	_____
8	_____
9	_____
10	_____
11	_____
12	_____
13	_____
14	_____
15	_____
16	_____

Area Name

17	_____
18	_____
19	_____
20	_____
21	_____
22	_____
23	_____
24	_____
25	_____
26	_____
27	_____
28	_____
29	_____
30	_____
31	_____
32	_____

User Profiles Record

Note: For All/Perimeter or Home/Sleep/Away systems use the default profiles 1 through 10. For Home/Sleep/Away with Guest systems use the default profiles 2 through 9 for the main house system, default profiles 12-19 for the Guest 1 house system, and default profiles 22-29 for the Guest 2 house system.

Profile #	Profile Name	Arm/Disarm Areas	Access Areas	Output Group	Arm	Disarm	Alarm Silence	Sensor Reset	Door Access	Armed Area	Outputs On/Off	Zone Status	Bypass Zones	Zone Monitor	System Status	System Test	User Profiles	User Codes	Schedules	Time	Display Events	Service Request	Fire Drill	Extend Schedules	Temp User Code	Anti-passback	Easy Arm/Disarm	Shift Time Access	Re Arm Delay	Sec Language	
																												1 2 3 4 A			
																													1 2 3 4 A		
																													1 2 3 4 A		
																													1 2 3 4 A		
																													1 2 3 4 A		
																													1 2 3 4 A		
																													1 2 3 4 A		
																													1 2 3 4 A		
																													1 2 3 4 A		
																													1 2 3 4 A		
																													1 2 3 4 A		
																													1 2 3 4 A		
																													1 2 3 4 A		
																													1 2 3 4 A		
																													1 2 3 4 A		
																													1 2 3 4 A		
																													1 2 3 4 A		
																													1 2 3 4 A		
																													1 2 3 4 A		
																													1 2 3 4 A		

User Codes Record

As you add new users or change current user codes, you can keep track of their profile number in the system. Use the following table to track custom user codes in your system. Only 4-digit user codes can be assigned to All/Perimeter, Home/Sleep/Away, or Home/Sleep/Away with Guest system users.

User #	User Name	Profile #

User #	User Name	Profile #

Schedules Record

Schedule	Area Name	Status	SUN	MON	TUE	WED	THU	FRI	SAT	HOL A	HOL B	HOL C
S1 S2 S3 S4 Area #		Open Close	: _M : _M	: _M : _M	: _M : _M	: _M : _M	: _M : _M	: _M : _M	: _M : _M	: _M : _M	: _M : _M	: _M : _M
S1 S2 S3 S4 Area #		Open Close	: _M : _M	: _M : _M	: _M : _M	: _M : _M	: _M : _M	: _M : _M	: _M : _M	: _M : _M	: _M : _M	: _M : _M
S1 S2 S3 S4 Area #		Open Close	: _M : _M	: _M : _M	: _M : _M	: _M : _M	: _M : _M	: _M : _M	: _M : _M	: _M : _M	: _M : _M	: _M : _M
S1 S2 S3 S4 Area #		Open Close	: _M : _M	: _M : _M	: _M : _M	: _M : _M	: _M : _M	: _M : _M	: _M : _M	: _M : _M	: _M : _M	: _M : _M
S1 S2 S3 S4 Area #		Open Close	: _M : _M	: _M : _M	: _M : _M	: _M : _M	: _M : _M	: _M : _M	: _M : _M	: _M : _M	: _M : _M	: _M : _M
S1 S2 S3 S4 Area #		Open Close	: _M : _M	: _M : _M	: _M : _M	: _M : _M	: _M : _M	: _M : _M	: _M : _M	: _M : _M	: _M : _M	: _M : _M
S1 S2 S3 S4 Area #		Open Close	: _M : _M	: _M : _M	: _M : _M	: _M : _M	: _M : _M	: _M : _M	: _M : _M	: _M : _M	: _M : _M	: _M : _M
S1 S2 S3 S4 Area #		Open Close	: _M : _M	: _M : _M	: _M : _M	: _M : _M	: _M : _M	: _M : _M	: _M : _M	: _M : _M	: _M : _M	: _M : _M
S1 S2 S3 S4 Area #		Open Close	: _M : _M	: _M : _M	: _M : _M	: _M : _M	: _M : _M	: _M : _M	: _M : _M	: _M : _M	: _M : _M	: _M : _M
Door# Output #		Open Close	: _M : _M	: _M : _M	: _M : _M	: _M : _M	: _M : _M	: _M : _M	: _M : _M	: _M : _M	: _M : _M	: _M : _M
Door# Output #		Open Close	: _M : _M	: _M : _M	: _M : _M	: _M : _M	: _M : _M	: _M : _M	: _M : _M	: _M : _M	: _M : _M	: _M : _M
Door# Output #		Open Close	: _M : _M	: _M : _M	: _M : _M	: _M : _M	: _M : _M	: _M : _M	: _M : _M	: _M : _M	: _M : _M	: _M : _M
Door# Output #		Open Close	: _M : _M	: _M : _M	: _M : _M	: _M : _M	: _M : _M	: _M : _M	: _M : _M	: _M : _M	: _M : _M	: _M : _M

Holiday Date Record

Your system has up to 20 holiday dates available that supersede all regular scheduled times for that day.

Date (mm/dd) HOL (circle one)

- | | | |
|-----|-----------|-------------|
| 1. | ____/____ | A or B or C |
| 2. | ____/____ | A or B or C |
| 3. | ____/____ | A or B or C |
| 4. | ____/____ | A or B or C |
| 5. | ____/____ | A or B or C |
| 6. | ____/____ | A or B or C |
| 7. | ____/____ | A or B or C |
| 8. | ____/____ | A or B or C |
| 9. | ____/____ | A or B or C |
| 10. | ____/____ | A or B or C |
| 11. | ____/____ | A or B or C |
| 12. | ____/____ | A or B or C |
| 13. | ____/____ | A or B or C |
| 14. | ____/____ | A or B or C |
| 15. | ____/____ | A or B or C |
| 16. | ____/____ | A or B or C |
| 17. | ____/____ | A or B or C |
| 18. | ____/____ | A or B or C |
| 19. | ____/____ | A or B or C |
| 20. | ____/____ | A or B or C |

Output Record

Your system has outputs that are used to control various functions within the building or access around its perimeter. The list below identifies the output numbers and device names.

Output # Output Name

_____	_____
_____	_____
_____	_____
_____	_____
_____	_____
_____	_____
_____	_____
_____	_____
_____	_____
_____	_____
_____	_____
_____	_____
_____	_____
_____	_____
_____	_____
_____	_____
_____	_____
_____	_____
_____	_____
_____	_____
_____	_____

Use the Output number in the User Menu when setting Output Schedules or using the Outputs ON OFF option to manually toggle the relays.

Appendix A

About the Display Events Section

This section of the User's Guide shows the Display Events items. While in the Display Events function, use the COMMAND and Back Arrow keys to go forward or backward through the list of events.

To view more information about each display, press the Select key as directed in the explanations below.

Using the Display Events

1. Access the User Menu.
2. Press the COMMAND key until DISPLAY EVENTS? displays. Press any Select key.
3. The keypad displays FRST LST PRT SRT. Select FRST (first) to view the oldest to newest events. Select LST (last) to view the newest to oldest events. If you select FIRST, use the COMMAND key to scroll up through the events. If you select LAST, use the Back Arrow key to scroll down through the events.

Select SRT to sort through the Display Events log and collect information specific to a user or system event.
Select PRT to print the complete Display Events log.
4. To use the Sort feature, select SRT. The keypad displays FRST DATE: 8/21. Press any Select key and enter a 4-digit beginning date for the sort. Press COMMAND.
5. The keypad displays LAST DATE: 10/17. Press any Select key and enter a 4-digit ending date for the sort. Press COMMAND.

6. The keypad displays USER NUMBER: -. To sort events for a particular user, enter their user number or press COMMAND to sort for all users. To search for a user, press any Select key then use the COMMAND and Back Arrow keys to browse through the user names in the system. When the user you want displays, press any Select key then press COMMAND.
7. The keypad next displays five event types that you can include in the sort. Press the fourth Select key to display YES when the event type name displays on the keypad. Press COMMAND. The following are the sort event types:
ACCESSES = door accesses granted.
DOOR NUMBER = leave blank for all doors.

Note: If you select yes for access then only Door Access Granted Events are included in the sort.

- ZONE EVENTS** = zone alarms, troubles, and restorals.
 - ARM/DISARM** = arming and disarming events.
 - USER EVENTS** = adding, deleting, and changing user codes.
 - SUPERVISORY** = system hardware problems and door access denied events.
8. After the last event type displays, the keypad again displays FRST LST PRT SRT. You can now view or print the sorted Display Events or press SRT to define a new sort.

Arming and Disarming Event Displays

This displays any system area arming or disarming events.

Keypad Display

ARM	5:10P	10/17
WAREHOUSE		

Description

The Warehouse was armed on October 17 at 5:10 PM. Press any Select key to display the area number and user number, and then any Select key to display the user name.

Arming Event Types - There are two event types you may see:

ARM - User armed the system **DIS** - User disarmed the system

Zone Event Displays

This displays alarms, troubles, and other events that may occur on your protection zones.

Keypad Display

ALR	10:23P	10/17
BASEMENT DOOR		

Description

An alarm occurred on October 17 at 10:23 PM. Press any Select key to see the zone number and zone type.

Zone Type - There are seven possible zone types you may see:

FIRE - Fire **PANC** - Panic **BURG** - Burglary
EMRG - Emergency **SUPV** - Supervisory
AUX1 - Auxiliary 1 **AUX2** - Auxiliary 2

Event Types - There are seven event type you may see:

ALR - Alarm **TBL** - Trouble **RST** - Restore
FLT - Zone Fault **SVC** - Service smoke detector
LOW - Low battery **MIS** - Missing wireless transmitter

Note: LOW and MIS are for wireless systems only.

Supervisory Event Displays

This displays the date and time of an automatic test report.

Keypad Display

MSG	11:58P	10/17
AUTO RECALL		

Description

The test report was sent to the central station at the date and time shown.

User Code Change Event Displays

This displays any addition, deletion, or change to a user code.

Keypad Display

ADD	11:41A	10/17
U:19	BY	U:12

Description

User 19 added at 11:41 AM by user 12. Select either user (US:) number for the user name.

User Code Event Types - There are three event type you may see:

ADD - User added **DEL** - User deleted
CHG - User code or authority level changed.

Zone Bypass Event Displays

This displays zone bypass events.

Keypad Display

BYP	5:18P	10/17
EAST WINDOW		

Description

The east window zone was bypassed. Press any Select key for the zone number and user number. Press again for the user name.

Bypass Event Types - There are three event types:

BYP - Bypass **RST** - Restore **FRC** - Force Arm

Note: You may sometimes see the user as SWG. This is short for Swinger Bypass which is an automatic function that allows the system to automatically bypass a zone.

Door Access Event Displays

This displays the keypad address where a Door Access occurred and the user number of the person granted access.

Keypad Display

ACC	5:18P	10/17
3	USER:024	

Description

User 24 accessed door (keypad) #3 at 5:18 PM on October 17. Press the first Select key to display the Door name where the access occurred. Press the second Select key to display the reason access was denied. Press the third Select key for the name of the device, or the fourth Select key for the user name.

About Door Access

Door Access is a feature available on certain keypads that contain a built-in door releasing relay and proximity readers. When power for an electric door strike or magnetic lock is connected to the relay contacts, only users entering a valid user code can release the lock and gain access to the area.

The Display Events feature logs the user number and name of the person granted access, the date and time, and from which keypad they entered their code.

System Monitor Event Displays

This displays any problems with the system AC power, battery, or phone line(s), or any opening of a tampered panel box.

Keypad Display

TBL	11:41A	10/17
POWER		

Description

An AC failure occurred on October 17 at 11:41 AM.

System Monitor Event Types - There are two event types:

TBL - Trouble **RST** - Restore

System Monitor Event Names - There are five system monitors:

POWER - AC power to panel **BATTERY** - On panel

LINE 1 - Phone line number 1 **LINE 2** - Phone line number 2

TAMPER - On panel box

Schedule Change Event Displays

This displays Changes made to the system schedules.

Keypad Display

S1	9:41A	10/17
MON	USER:024	

Description

S1 schedule for Monday was changed by user 24 at 9:41 AM on October 17.

Schedule Types - There are five possible schedule types:

S1 S2 S3 S4 - Standard **OUT** - Output
DOOR - Door **HOL** - Holiday **EXT** - Extend

MON - This is the day of the week in which the schedule change occurred. The days display using three letters. Press the first Select key to display the scheduled Opening time and once again for the scheduled Closing time.

024 - User number of the person who made the change. Press the third Select key under 024 to display the user name.

Wireless Jamming Event Displays

This displays wireless jamming events that have occurred.

Keypad Display

ALM	11:41A	10/17
WIRELESS		

Description

The DMP wireless receiver detected jamming on October 17 at 11:41 AM.

Wireless Jamming Event Types - There are three event types:

TBL - Trouble (a jamming event occurred when the panel was disarmed)
ALM - Alarm (a jamming event occurred when any area was armed)
RST - Restore

Note: Trouble and Restore events display WIRELESS as the device.

Wireless Trouble Event Displays

This displays events when the wireless receiver was not communicating with the panel.

Keypad Display

TBL	11:41A	10/17
WIRELESS		

Description

A DMP wireless device trouble occurred on October 17 at 11:41 AM.

Wireless Trouble Event Types - There are two event types:

TBL - Trouble **RST** - Restore

Note: Trouble and Restore events display WIRELESS as the device.

Appendix B

Zone Status Browser

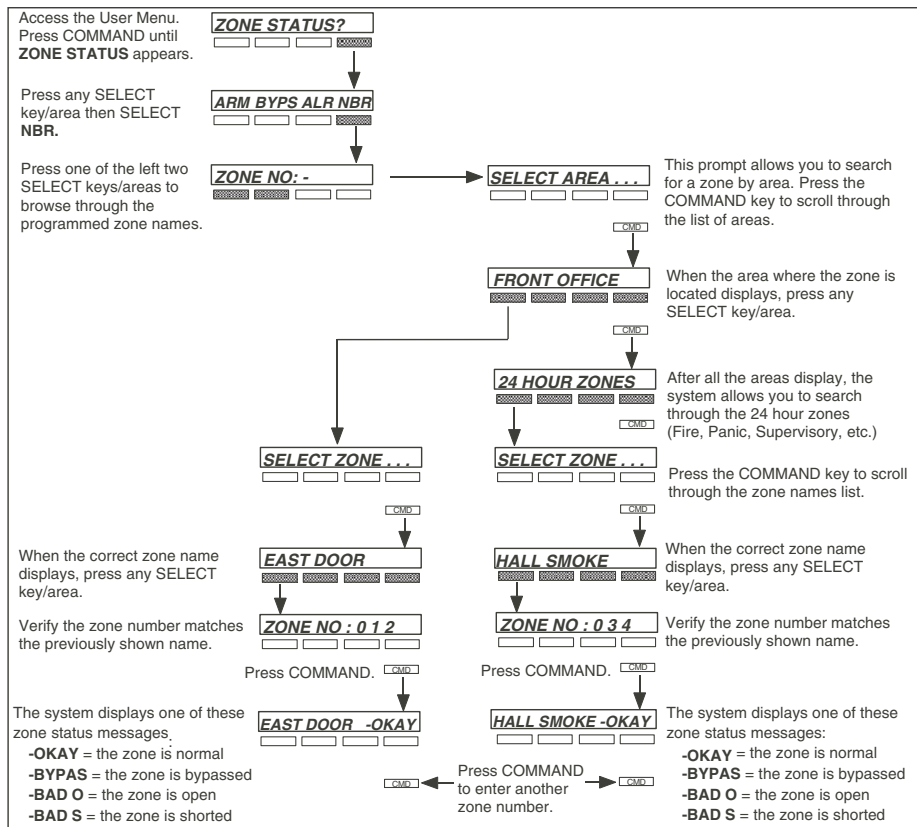

Bypass Zones Browser

Access the User Menu.
Press COMMAND to display **BYPASS ZONES**.
Press any SELECT key/area.

BYPASS ZONES?

Press either of the two left SELECT keys/areas.

ZONE: - RST BYP

This prompt allows you to search for a zone by area.
Press the COMMAND key to scroll through the list of areas.

SELECT AREA ...

When the area where the zone is located displays, press any SELECT key/area.

FRONT OFFICE

CMD

Press the COMMAND key to scroll through the zone names list.

SELECT ZONE ...

CMD

When the correct zone name displays, press any SELECT key/area.

EAST DOOR

The display shows the zone number. SELECT **RST** to Reset the zone. SELECT **BYP** to Bypass the zone.

ZONE:012 RST BYP

The display returns to the **ZONE:** prompt allowing you to enter another zone number.

ZONE: - RST BYP

Zone Monitor Browser

Access the User Menu. Press COMMAND until **ZONE MONITOR?** displays. Press any SELECT key/area.

ZONE MONITOR?

SELECT **NBR**.

ALL NBR

Press either of the two left SELECT keys/areas.

ZONE: - ADD RMV

This prompt allows you to search for a zone by area. Press the COMMAND key to scroll through the list of areas.

SELECT AREA ...

When the area where the zone is located displays, press any SELECT key/area.

FRONT OFFICE

CMD

Press the COMMAND key to scroll through the zone names list.

SELECT ZONE ...

CMD

When the correct zone name displays, press any SELECT key/area.

EAST DOOR

The display shows the zone number.

ZONE:012 ADD RMV

Selecting **ADD** places the zone in monitor mode.

Selecting **RMV** removes the zone from monitor mode.

Add User Codes Browser

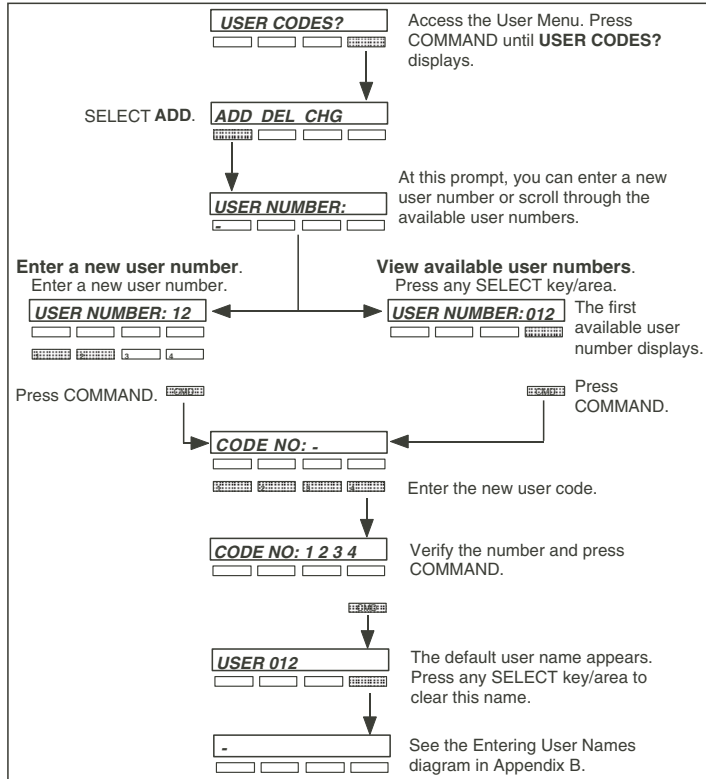

Change User Codes Browser

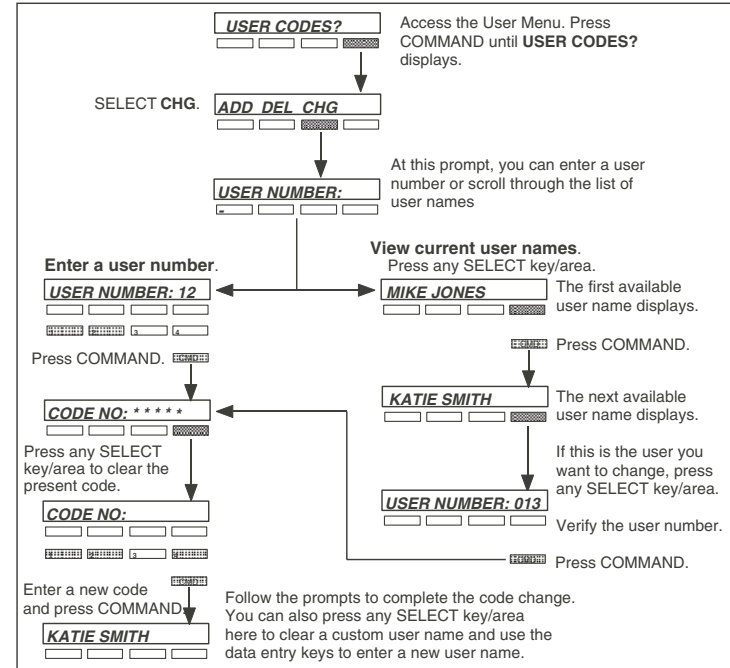

Delete User Codes Browser

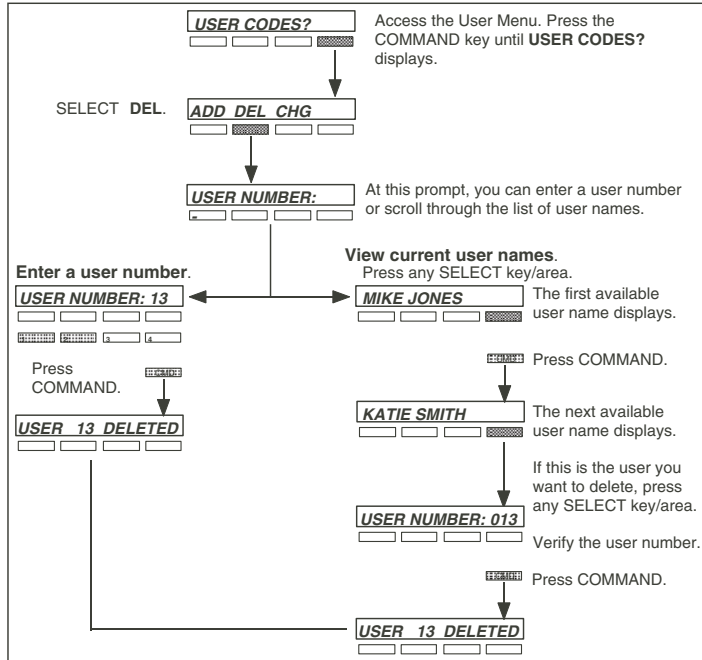

Add User Profiles Browser

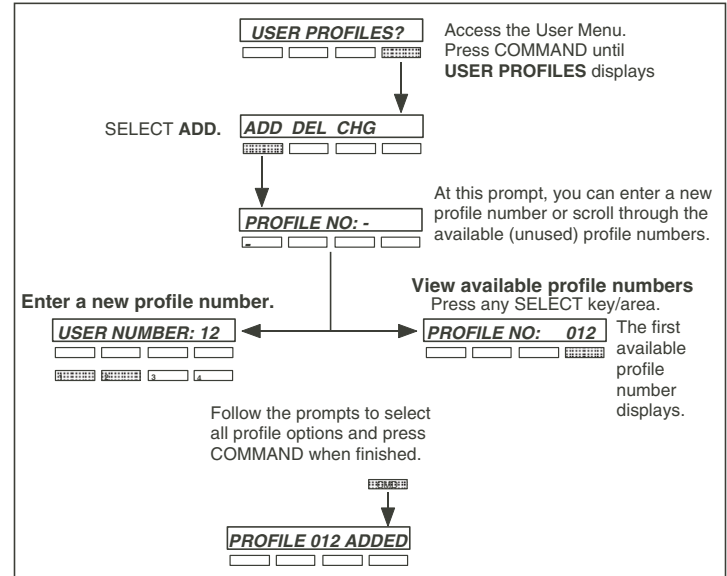

Change User Profiles Browser

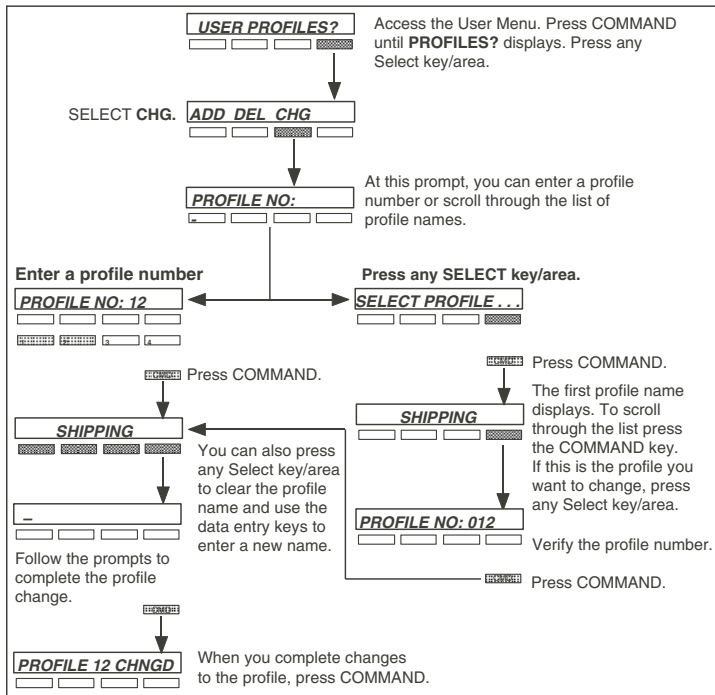

Delete User Profiles Browser

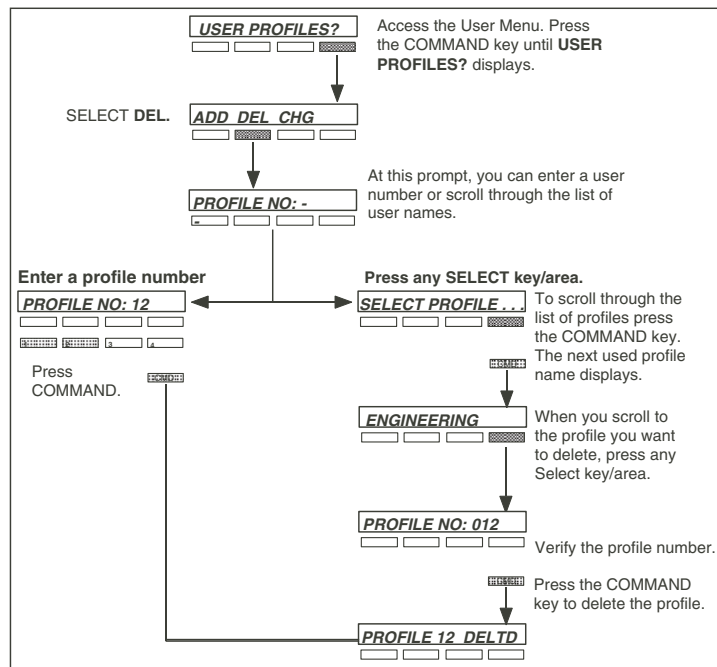

Output Groups Browser

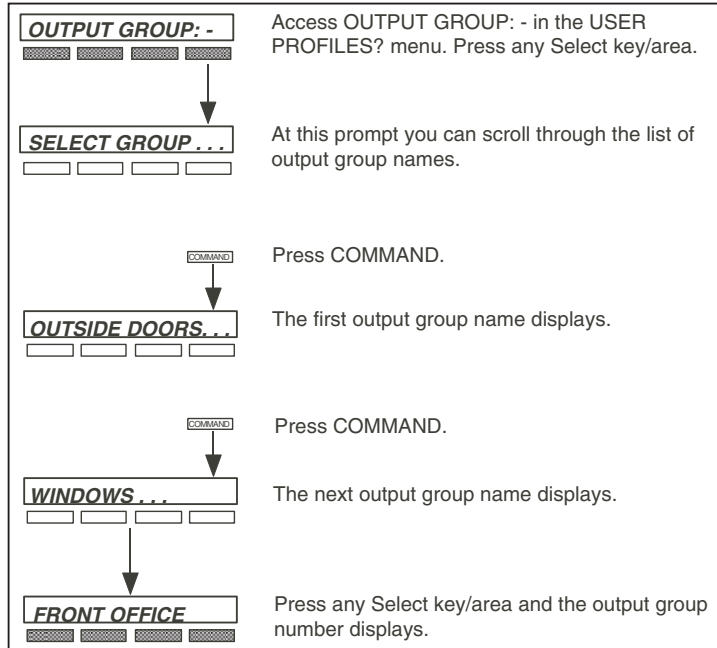

Outputs On/Off Browser

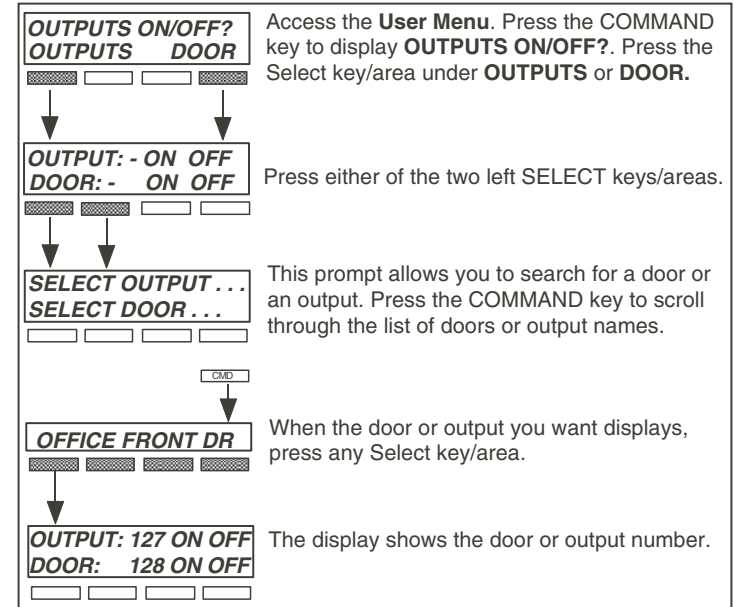

Appendix C

User Disarm and Entry

Use the following steps to disarm your system and silence an alarm.

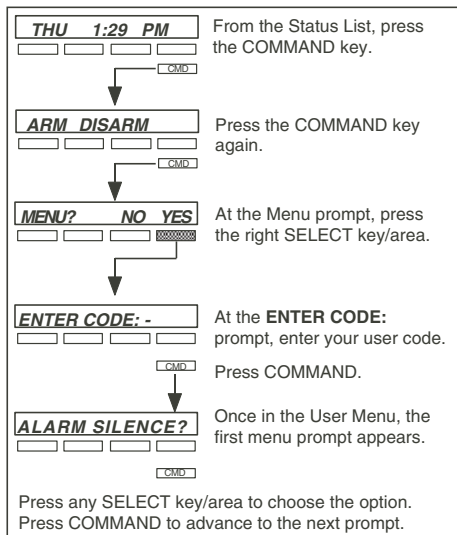

Entering User Names

Refer to the following when entering names information into the keypad.

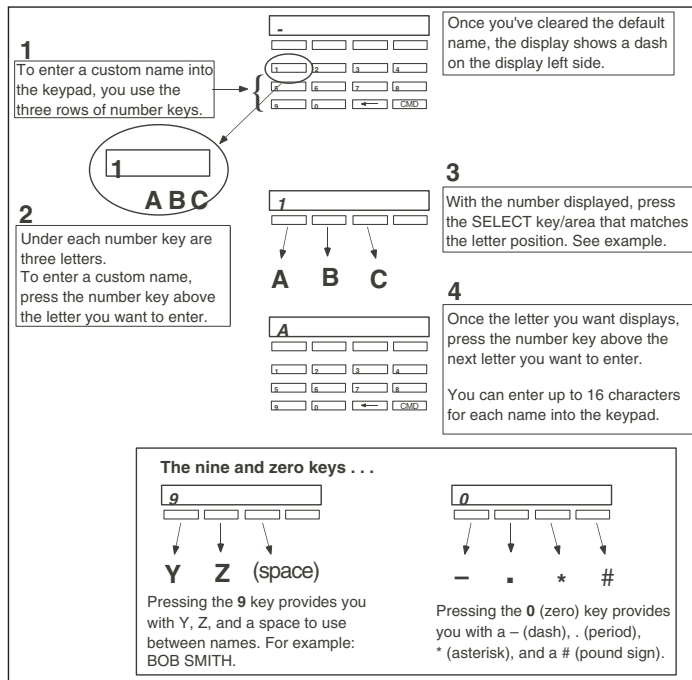

Appendix D

DMP Wireless Description

If your system uses DMP Wireless devices and includes key fob(s), refer to the following information. The DMP Wireless section includes a brief discussion of key fob(s) and a drawing identifying the key fob buttons. Refer to the System Setup section of this guide to check the button programming list for key fob(s) connected to your system.

For best operation, allow the LED to light and turn off before pressing another button. The key fob may not complete sending the signal for the button press if another button is pressed too soon.

LED Status Operation

Depending on the programmed action of a key fob button, the Status LED lights to acknowledge a button press or to indicate the armed state of the system.

- When the button is programmed for Panic, Panic 2, Emergency, Emergency 2, Output, or Sensor Reset, a 1/2 second Green light displays to acknowledge the button press.
- When the button is programmed for Arm, Disarm, Toggle arm/disarm, or Status, the system armed status is received by the key fob and the LED lights once as shown in the table below.

LED Color	Duration	Description
Red	2.0 Seconds	All System On
Green	2.0 Seconds	All System Off
Green/Red	2.0 Seconds	System On (Some Areas Armed)

When a button programmed as Unused is pressed, the LED does not operate.

Appendix E

Easy Entry™ User's Guide

Door Strike

From the Status List, present your card to the reader. Once validated by the system, the Door Strike relay activates. If you are entering an armed area to which you are assigned, accessing the area automatically causes it to be disarmed.

While the keypad displays the Status List, present your access card. The relay activates momentarily during which you must open the door. Once you open the door, you have 30 seconds to exit and close the door before the zone 2 Soft-Shunt expires and triggers an alarm.

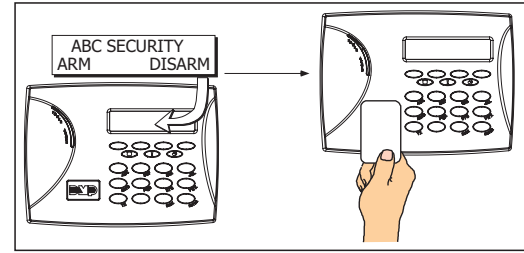

Arming and Disarming an Area System

Press Command, the keypad displays **ARM DISARM**. Press the Select key under the desired option. The keypad displays **ENTER CODE-**. Present your card to the reader. Once validated by the system, all areas assigned to your code arm or disarm automatically. Select **NO** to arm or disarm individual areas. Select **YES**, or simply wait, and the keypad automatically arms or disarms all areas for which you are authorized.

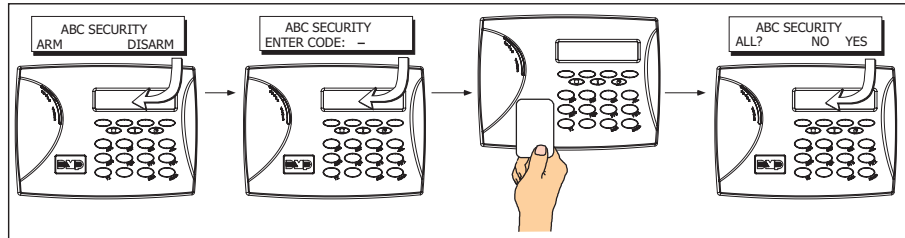

Arming and Disarming an All/Perimeter System

Press **COMMAND**. The keypad displays **PERIM ALL** (when arming) or **DISARM?**. Press the Select key under the desired option. The keypad displays **ENTER CODE: -**.

Present your card to the reader. Once the system validates the card, if you choose **PERIM**, only the perimeter arms. If you choose **ALL**, both areas arm. If programmed on a 32-character keypad, **ALL** may be automatically chosen for you after a short delay. Present your card to the reader and all armed areas disarm automatically.

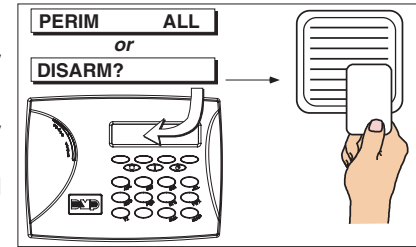

Arming and Disarming a Home/Sleep/Away System and a Home/Sleep/Away with Guest System

Present your card to the reader. If the system is armed, once the system validates the card, all areas are disarmed and the keypad displays **ALL SYSTEM OFF**.

If the system is disarmed when you present your card, once the system validates the card, **HOME SLEEP AWAY** displays. You can manually press the Select key under the desired option or after short time all areas may be automatically armed in the **AWAY** mode.

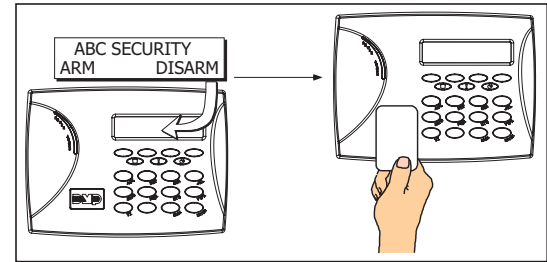

Disarming with Entry Delay

All Systems - Once the protected door is opened and the entry delay starts, the keypad displays **ENTER CODE: -**. Present your card to the reader. Once validated, the system disarms all areas accessible by you. Area systems provide a delay to allow selected areas only to be disarmed. See Arming and Disarming above and on the previous page.

Using the Access Reader for User Menu Access

You can also use a card reader to access the User Menu. When **MENU? NO YES** displays, select YES and enter a code when requested.

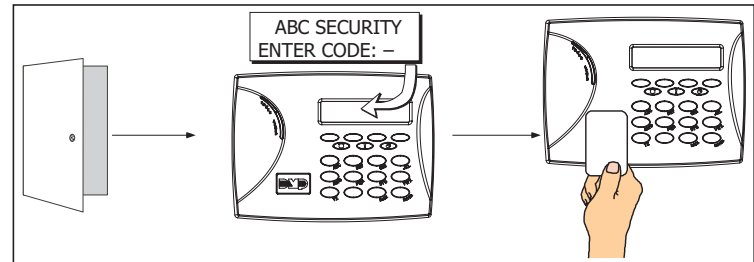

Appendix F

Email/Cell Phone Message User's Guide

Your security system's reporting capability can be used to send reports to an email address or cell phone number in much the same way as someone sending you an email would do. You can receive reports of alarms, troubles, or system arming and disarming and know at a glance your system status.

The following are types of messages that can be sent:

- * Zone Alarms by Zone Name
- * Zone Bypass by User
- * Disarming (Openings) by User
- * AC Power (and restoral)
- * Ambush
- * Alarm Verified by User
- * Zone Troubles by Zone Name
- * Armings (Closings) by User
- * Late to Close
- * System Low Battery
- * Abort & Cancel by User
- * System Test

For alarm messages, the message provides the system name, zone name, zone number, message type, and the time at which the panel sent the message.

For alarm messages sent to a cell phone number, you have the option to reply with "cancel" to cancel the existing alarm.

From: John's Home System (mailto: AlarmAdmin@ABCSecurity.com)
Sent: Wednesday, October 07, 2009 8:33 AM
To: JohnSmith@myhome.com
Subject: Fire Alarm Message

The John's Home System has a ****Fire Alarm**** on the Hall Smoke Alarm.
Message sent at: 8:31 AM

From: John's Home System (mailto: AlarmAdmin@ABCSecurity.com)
Sent: Wednesday, October 07, 2009 9:01 AM
To: JohnSmith@myhome.com
Subject: Check-in Message

Cindy H has checked in at the John's Home System.
Message sent at: 9:00 AM

From: John's Home System (mailto: AlarmAdmin@ABCSecurity.com)
Sent: Wednesday, October 07, 2009 10:05 AM
To: JohnSmith@myhome.com
Subject: System Message

John's Home System has an AC Power Failure.
Message sent at 10:02 AM

Examples of email messages

In Touch™ Text Messaging Commands

Your system may be programmed to allow simple text messages to be sent to the security system to perform basic user operations. By texting a message from your cell phone or PDA, the following actions can be performed: Arm/Disarm, Cancel Alarm, turn Outputs On/Off, and check Armed Status.

The user that is texting commands to the system must have the authority to perform the commands as if it occurred at the keypad. The cell phone number and user numbers are setup during programming.

After programming is completed, you will receive a welcome message text from the panel. Write down the phone number that the message comes from. This will be the number you use to text user operations to the system.

Note: When texting commands listed below, the commands can be either upper or lowercase.

A list of In Touch™ SMS Text commands can be obtained by texting “help” to the system phone number. Store this number in your cell phone and write the number on the Quick Reference Wallet Card located at the back of this manual.

Arming All Areas with Text Message Commands

1. Text message your system panel with the following command:
 - ARM, AWAY, or ALL: To arm all areas, depending on your system

Arming Partial Areas with Text Commands

1. Text message your system panel with the following command:
 - SLEEP: To arm the perimeter and interior of a Home/Sleep/Away system.
 - HOME: To arm just the perimeter of a Home/Away/Sleep system.
 - PERIM: To arm the perimeter of an All/Perimeter system.
 - ARM “Area Number” or ARM “Area Name”: To arm specific areas of an Area system.

The NAME should identify the area name. The NUMBER should identify the area number. Names and numbers can be mixed. A comma should be used to separate areas. If only ARM is sent, all areas are armed.

If the system is already armed, you can arm it again only if you are arming more areas than were originally armed.

Disarming All Areas with Text Message Commands

1. Text message your system panel with the following command:
 - DISARM: To disarm all areas.

Disarming Partial Areas with Text Message Commands

1. Text message your Area system panel with the following command:
 - DISARM “Area Number” or DISARM “Area Name”: To disarm specific areas of an Area system.

The NAME should identify the area name. The NUMBER should identify the area number. Names and numbers can be mixed. A comma should separate the areas. If only DISARM is sent, all areas will be disarmed.

If the system is already disarmed, you will receive a message saying the system is already disarmed.

Canceling an Alarm with Text Messaging

While the alarm bell or siren sounds, you may choose to cancel the alarm via text messaging.

1. If a valid alarm has not occurred, text **CANCEL** to disarm the system and cancel the alarm.

Turning Outputs On/Off/Momentary with Text Messaging

Allows you to set the state of any output to on, off, or momentary.

1. To set the Output to ON Steady, text ON followed by the Output name or number. For example, to turn Output 3 on, you would text: ON 3 or ON LIGHTS.
2. To turn the Output to OFF, text OFF followed by the Output name or number. For example, to turn Output 3 off, you would text: OFF 3 or OFF LIGHTS.
3. To turn the Output to ON MOMENTARY (the output turns on for one second, and then off), text MOMENTARY followed by the Output name or number. For example, to turn Output 3 to momentary, you would text: MOMENTARY 3 or MOMENTARY LIGHTS.

Check Armed Status Text Command

Allows you to check the system armed status. If armed, the system will send a message stating the type of system you have followed by ON, such as ALL SYSTEM ON or HOME SYSTEM ON. If disarmed and no open zones, the system will send SYSTEM READY. If disarmed with open zones, it will send SYSTEM NOT READY followed by any open zones. A message of AC POWER TROUBLE will indicate when a power failure occurs. If in alarm or trouble, the system will send ALARM ON or TROUBLE ON followed by up to 3 zone names that are in alarm or trouble.

1. To receive the Armed Status, text: STATUS.

Subscribe to Text Messages

Allows you to set which text messages you receive from the panel. When your system is programmed to allow text messages, you will automatically be subscribed to ALL as described below. To change your subscription status, follow the instructions below for desired messages.

1. Text the words SUBSCRIBE STATUS ALL to receive a text message for all arming and disarming occurrences in addition to any alarm.
2. Text the words SUBSCRIBE STATUS NONE to not receive a text message for arming and disarming occurrences, but still receive a text message for any alarm.
3. Text the words SUBSCRIBE STATUS OTHERS to receive a text message for all arming and disarming occurrences originating from other users, in addition to any alarm. This option will send a text message for all arming and disarming occurrences except for the ones you initiate at a keypad.
4. Text the word SUBSCRIBE to show the current subscription status and the available subscription options.

Frequently Asked Questions

This section attempts to answer questions you might have regarding system operation.

Q. If I bypass an exit delay door when I arm the system, will I get an alarm if I come through it later?

A. You will not get an alarm from the door because it is bypassed, but if you happen to walk through a motion detector space or other armed door inside the premises an alarm activates.

Q. When I arm or disarm my Area system, **ALL? NO YES** displays. Does this mean all areas in the system?

A. Selecting **YES** arms or disarms all areas that are authorized for your user code.

Q. How do I create a schedule that starts at 8:00 AM on Monday and ends at 5:00 PM on Friday.

A. In the days of the week display, select **MON** (Monday). For the **OPENING TIME?**, enter 0 + 8 + 0 + 0 AM. For the **CLOSING TIME?**, at the **MON – : AM PM** display, select **MON**; this scrolls through the days of the week. Stop at the day you want the schedule to end. Next, enter 0 + 5 + 0 + 0 PM into the **FRI – : AM PM** closing time display. Press **COMMAND**. Press the Back Arrow key to exit the User Menu.

This sets the opening time to 8:00 AM Monday and the closing time to 5:00 PM Friday. You can substitute any other day or time in this example.

Q. What do I do if I want to be in the building past the scheduled closing (arming) time?

A. If your system is programmed for closing check, the keypad emits a steady tone prior to the system arming. During this tone, press any Select key to display **ENTER CODE: .** Enter your user code and press **COMMAND**.

The keypad now displays **2HR 4HR 6HR 8HR**. Select the number of hours to extend the schedule. If the system is not armed by the scheduled closing time, a Late to Close report is sent to the central station. If the schedule is extended, a Schedule Change report may be sent to the central station.

Common Keypad Displays

Listed below are several keypad messages you may see on the display. Follow the instructions in the Possible Solutions column to correct the problem. In many cases, you need to call a service person to correct the problem. Displays that are not discussed here mean that your service representative should be called.

Message	Meaning	Possible Solutions
INVALID AREA	The user has attempted a door access for an area they are not assigned.	Change the user access areas if access to the area is needed. If access is not needed, the user cannot enter the area.
INVALID CODE	The user code you entered is not recognized by the system.	Check the user code and try again.
INVALID PROFILE	A user has attempted a function that is outside of the assigned profile.	Check the user profile settings.
INVALID TIME	A user code assigned to a specific schedule has entered outside of the valid schedule.	See Schedules and User Codes.
ENTER 2ND CODE	The area you are attempting to disarm or access is a Two Man Area.	A second and different user code must be entered.
CLOSING TIME	The scheduled has expired but the area has not been armed.	Users still on the premise should arm the system or extend the schedule to a later time.
LATE TO CLOSE	The system was not armed at its scheduled closing time.	Users still on the premise should arm the system or extend the schedule to a later time.
FAILED TO EXIT	A user assigned the anti-passback option has attempted to re-enter an area from which they did not exit properly.	The user must exit the area through the proper door. If not possible, your system administrator should select the Forgive option in the User Codes menu.

Index

Symbols

- 2-Button Panic Keys 5
- 7/0 Panic Function 5
- 24-hour Status 11

A

- Alarm Cancel 19, 21
- Alarm Silence b, 19, 21, 24
- Alarm Verify 19, 21
- All/Perimeter System
 - Alarm Silence b, 19
 - Arming 17, 63
 - Disarming 18, 63
 - Shortcut Keys 17, 22
 - User Code 33
- Ambush Codes 36
- Anti-Pass Back 10
- Anti Pass No 31
- Aqualite™ Keypad 3
 - Panic Keys 5
- Areas 10, 15
- AREA LATE! 36
- Area Names and Numbers Record 45
- Area System
 - Alarm Silence b
 - Arming 15
 - Disarming 16
- Armed Areas
 - Checking 16
 - Display 25
- Armed Status 12
- Arming 11, 13, 15

Index

- All/Perimeter System 17, 63
- Area System 15, 62
- Bypassing Zones 13
- Home/Sleep/Away System 19, 63
- Key Fob 14
- Quick Arming 16
- Selective 13
- Shortcut Keys 17, 19
- System 15

B

- Back Arrow (<—) Key 5
- Browser 12
 - Add User Codes 34, 56
 - Add User Profiles 30, 57
 - Bypass Zones 27, 55
 - Change User Codes 34, 56
 - Change User Profiles 31, 58
 - Delete User Codes 35, 57
 - Delete User Profiles 31, 58
 - Output Group 31, 59
 - Output On Off 25, 59
 - Zone Monitor 28, 55
 - Zone Status 26, 54
- Bypass Zones 13, 26
 - Browser 55

C

- Cancel Alarm b, 19, 21, 66
- Card Plus PIN (XR500E) 43
- Central Station Monitoring 11
- Clear Touch™ Keypad
 - Panic Icons 5

- CLOSING TIME! 36
- COMMAND (CMD) Key 5
- Common Keypad Displays 65, 68

D

- Data Entry Keys 5
- Date and Time 41
- Disarming 11
 - All/Perimeter System 18, 63
 - Area System 16, 62
 - Card Reader 16
 - Entry Delay 63
 - Home/Sleep/Away System 20, 63
 - Key Fob 15
 - Quick 17
 - Selective 16
 - System from Keypad 17
- Display Events 41, 42, 50
- Arming and Disarming 51
- Door Access 52
- Schedule Change 53
- Supervisory 51
- System Monitor 52
- User Code Change 51
- Wireless Jamming 53
- Wireless Trouble 53
- Zone 51
 - Zone Bypass 51
- DMP Wireless 8, 61
- Door Access 10, 24, 52
 - Disarming 16
- Door Strike 62

E

- Easy Entry™ User's Guide 62
- Emergency Evacuation 2
- Entering User Names 60
- Entry Delay 63
- Entry Zone 11
- Event Displays 42, 50
- Exit Zone 11
- Extending Schedules 21, 41

F

- Failure to Exit 35
- False Alarms 1
- Fault 11
- Fire Drill 42
- Forgive Failure to Exit 35
- Frequently Asked Questions 67

H

- Holiday Date
 - Record 49
 - Setting 40
- Home/Sleep/Away System
 - Alarm Silence b, 21
 - Arming 19, 63
 - Disarming 20, 63
 - Shortcut Keys 19, 22
 - User Code 33
- How Your System Operates 13

I

- Instant Arming 18
- Instant Zone 11

K

- Keypad
 - 2-Button Panic Keys 5
 - Common Displays 68
 - Displays 9
 - Key Definitions 5
 - LEDs 4
 - Multi-lingual Display 6, 23
 - Record 43
 - Select Keys 4
 - Shortcut Keys 22
 - Tones 7
 - Types 3
 - User Menu 1
 - User Options 5, 7
 - Wireless Displays 9
- Key Fob 8, 44, 61
 - Arming 14
 - Button Layout 8
 - Button Programming 44
 - Disarming 15
 - LED Operation 61
 - Status Table 61
 - User Record 44

L

- LCD Keypad 1
- LED Operation 4, 61

M

- Monitoring 11
- Multi-lingual Display 6, 23

O

- Outputs On Off 25
 - Browser 59
- Output Groups 30
 - Browser 59
- Output Relay Record 49

P

- Pager Direct™ 64
- Panic Zone Test (XR500 Series) 29
- PIN (XR500E) 33
- Power LED 4, 5
- Profiles 29
 - Adding 30, 57
 - Changing 30, 58
 - Chart 32
 - Deleting 30, 58
 - User Profile Record 46

Q

- Quick Arming 16
- Quick Disarming 17

R

- Re Arm Delay 31

S

- Schedules 16, 36
 - Door 37
 - Extending Schedules 10, 21, 41
 - Extend (EXT) 37
 - Holiday (HOL) 37
 - Output (OUT) 37
 - Record 48
 - Setting Holiday ABC Schedules 39
 - Setting Output and Door Schedules 38
 - Setting Shift Schedules 37
 - Shift (S1, S2, S3, S4) 37
 - Shift Time Access 31
- Security System Terms 10
- Select Keys 4
- Sensor Reset 24
- Service Request 42
- Shift Time Access 31
- Shortcut Keys 17, 19, 22, 24, 27
 - Arming Function 17, 19, 22
 - Monitor (Chime) Function 22, 27
 - Sensor (Fire) Reset Function 22, 24
- Silence Alarm b, 24
- Status 11
- Status List 12
- System Setup Record 43
- System Status 28
- System Test 1, 28

T

- TEMP CODE 31
- Thinline™ Keypad 4, 5, 7
 - LEDs 3
 - Panic Keys 5

U

- User Codes 33
 - Adding 33, 56
 - Changing 34, 56
 - Deleting 34, 57
 - Names 33, 60
 - Numbers 33
 - Record 47
- User Disarm and Entry 9, 60
- User Menu Options 23
 - Alarm Silence 24
 - Armed Areas Display 25
 - Bypass Zones 26
 - Door Access 24
 - Outputs On Off 25
 - Sensor Reset 24
 - System Status 28
 - System Test 28
 - Zone Monitor 27
 - Zone Status 26
- User Options 7
- User Profiles 29, 33
 - Adding 30, 57
 - Changing 30, 58
 - Chart 32
 - Deleting 31, 58
 - Record 46

V

- Verify Alarm b, 19, 21

W

- Wireless 8, 61
 - Jamming Event Display 53
 - Trouble Event Display 53

Z

- Zone 11
- Zone Monitor 27
 - Browser 55
- Zone Status 12, 26
 - Browser 54

This page intentionally left blank.

This page intentionally left blank.



Digital Monitoring Products



LT-0683 1.04 © 2012 Digital Monitoring Products, Inc.



12135

