

# XT30/XT50 USER GUIDE

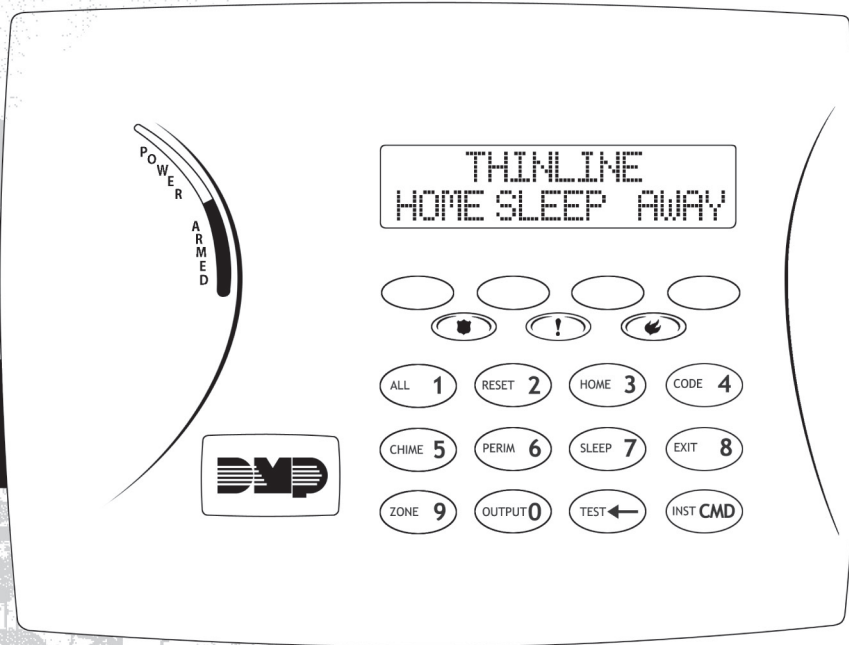

## Silencing an Alarm

When the alarm bell or siren is sounding, enter your user code or present your card to a keypad or reader during the Status List display.

### **All/Perimeter or Home/Sleep/Away System**

CANCEL VERIFY displays.

- If a burglar alarm is valid, press VERIFY to send a verification message to the Central Station.
- If a valid alarm has not occurred, press CANCEL to cancel the alarm and send an Abort or Cancel message to the Central Station. The keypad displays ALARM CANCELLED and the security system will be disarmed.

### **What to do when a trouble tone is sounding**

You can silence the trouble tone by pressing any key. This only silences the keypad and does not correct the condition that originally caused the problem.

© 2012 Digital Monitoring Products, Inc.

Information furnished by DMP is believed to be accurate and reliable.  
This information is subject to change without notice.

# XT Series™ User's Guide for XT30/XT50 Series Panels

## Table of Contents

<i>Section</i>	<i>Page</i>	<i>Section</i>	<i>Page</i>
<b>Introduction .....</b>	<b>1</b>	<b>User Menu .....</b>	<b>21</b>
About Your Security System .....	1	Accessing the User Menu .....	21
Emergency Evacuation Plans .....	2	User Menu Options.....	21
Keypads .....	3	User Check-in.....	22
Special Keypad Tones .....	7	Zone Activity Check .....	22
1100 Series Wireless .....	8	Sensor Reset.....	23
Special Wireless Displays .....	8	Outputs On Off .....	23
Special Keypad Displays.....	8	Favorite .....	24
Email/Cell Phone Messages .....	9	Bypass Zones.....	24
MyAccess™ Text Messaging Commands .....	9	Zone Monitor .....	24
Understanding Security System Terms .....	9	Using the Zone Monitor Function .....	25
<b>Arming and Disarming.....</b>	<b>12</b>	System Test.....	25
How Your System Operates.....	12	User Codes .....	26
Arming Functions .....	12	Schedules.....	29
Key Fob Arming.....	13	Permanent Schedules .....	29
Key Fob Disarming .....	13	Extending Schedules .....	30
Area System Arming .....	13	Output Schedules.....	30
Area System Disarming.....	14	Favorite Schedules .....	31
All/Perimeter System Arming.....	15	Date and Time .....	32
All/Perimeter System Disarming.....	16	Display Events .....	32
Home/Away System Arming .....	17	Request Service?.....	32
Home/Away System Disarming.....	18		
Keypad Shortcut Keys.....	19		

<b>System Setup .....</b>	<b>33</b>	<b>Appendix D .....</b>	<b>44</b>
System Setup Record.....	33	Email/Cell Phone Message User's Guide .....	44
Protection Areas.....	33	MyAccess™ Text Messaging Commands .....	45
Output Record .....	33	PhoneAccess™ User's Guide.....	48
Favorite List .....	34	Common Keypad Displays .....	49
Key Fob Button Programming .....	35	<b>Quick Reference Wallet Cards.....</b>	<b>53</b>
User Codes .....	35		
<b>Appendix A .....</b>	<b>37</b>		
About the Display Events Section.....	37		
Zone Activity Check Event Display .....	37		
Zone Bypass Event Displays .....	37		
Zone Event Displays .....	38		
Arming and Disarming Event Displays .....	38		
User Check-in Event Displays .....	38		
User Code Change Event Displays .....	38		
Supervisory Event Displays .....	39		
System Monitor Event Displays.....	39		
Wireless Jamming Event Displays .....	39		
Wireless Trouble Event Displays.....	39		
<b>Appendix B .....</b>	<b>40</b>		
1100 Series Wireless Description .....	40		
<b>Appendix C .....</b>	<b>41</b>		
User's Guide .....	41		
Entering User Names .....	43		

# Introduction

## About Your Security System

Your system is designed with your safety and comfort in mind. It uses the latest in computer technology to create the most advanced, user friendly, security, fire, and access control system available.

The system combines ease of use with a simple to understand keypad display to offer the full range of features requested by today's security system owners. Your security system can protect both the interior and perimeter of your home or business while you are away or just the perimeter when you are inside, giving you a wall of security and peace of mind.

You can turn portions of your protection on or off at any time by pressing a few keys. You can add, delete, and change personal user codes at any time or check the status of all protection devices in the system.

## Keypads

This is the device we have placed at certain locations throughout the premises that allows you to turn the system protection on and off using your personal user code.

## Keypad User Menu

The keypad provides a simple User Menu containing all of the functions you need to fully operate your system such as changing the time of day or a personal user code.

## A Note About False Alarms

One of the most important concerns facing the security industry today is false alarms. The accidental dispatching of police and fire agencies places others in jeopardy by limiting the response capability of those emergency service units.

As part of our commitment to reducing false alarms, we would like to encourage you to read this guide thoroughly. All the information contained here can help you quickly, and comfortably, learn the XT Series™ system operation.

**Note:** There may be a 30-second alarm communication delay pre-programmed at installation to allow disarming if a false alarm occurs. This delay is optional and can be removed or increased to 45 seconds by your alarm dealer.

## Test Your System Weekly

It is recommended that you test the burglary portion of your system at least once each week. Testing should involve an active test of all doors, windows, and motion detectors connected to your system. If your system also has fire protection, call the service department to find out how this portion of your system should be tested.

Refer to the System Test section of this guide for instructions on testing the burglary portion of your system.

## Emergency Evacuation Plans

### Overview

The National Fire Protection Association recommends that you establish an emergency evacuation plan to safeguard lives in the event of a fire or other emergency.

### Draw a floor plan of your home or business

On a clean sheet of paper, draw the walls, windows, doors, and stairs. Also draw any obstacles that a person may encounter while exiting the building such as large furniture or appliances.

### Develop escape routes

Determine at least two routes the occupants in each room can take to safely escape. One route can be the most obvious such as the door. Another can be through an easily opened window. If the window is high off the ground, an escape ladder should be provided.

Draw arrows on the floor plan to show escape routes from each room.

### Decide where to meet

Prefarrange a meeting place outside and away from where emergency personnel are likely to be working. A neighbor's house or across the street in front of the house are good locations. Always perform a head count to make sure all occupants safely exited. NEVER ENTER A BURNING BUILDING. If the head count shows one or more persons missing, give this information immediately to the authorities. Never enter a building to look for someone.

## Practice your escape plans

Devising an escape plan is only the beginning. For the plan to be effective everyone should practice escape routes from each room.

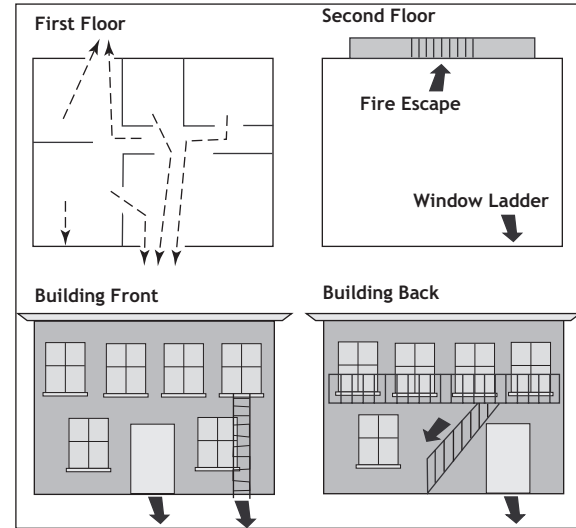

Figure 1: Sample Escape Route Map

### Early detection

The best way to survive a fire or other emergency is to get out early. A fire alarm system installation, with smoke and carbon monoxide detectors in each room, can greatly decrease your risk of loss or injury.

# Keypads

Your system may have one or more easy to use LCD keypads that allow you to properly operate the system.

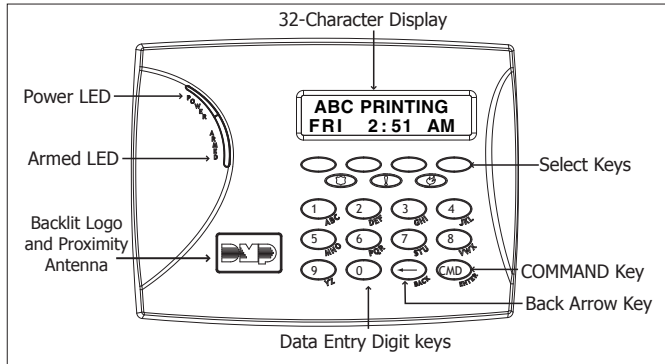

**Thinline™/Aqualite™ Keypad**

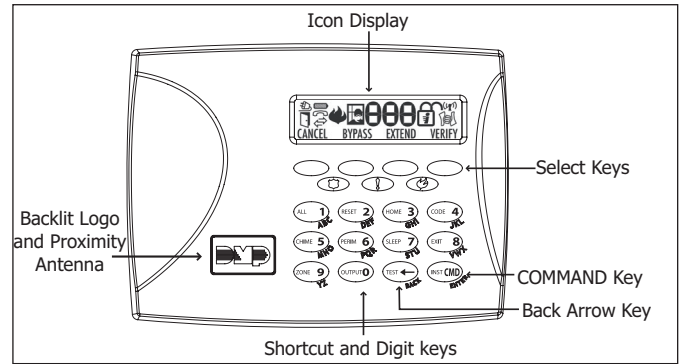

**Thinline™ Series Icon Keypad**

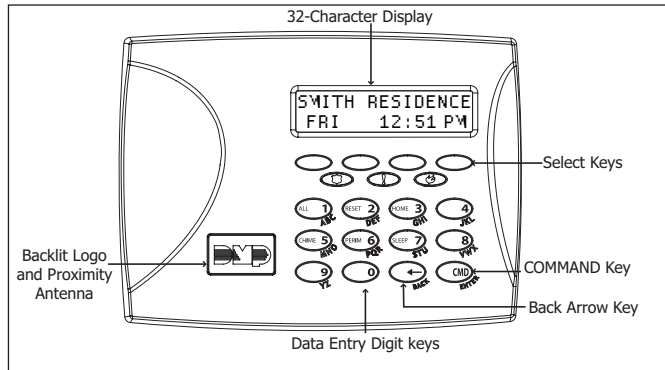

**Thinline™ Wireless Keypad**

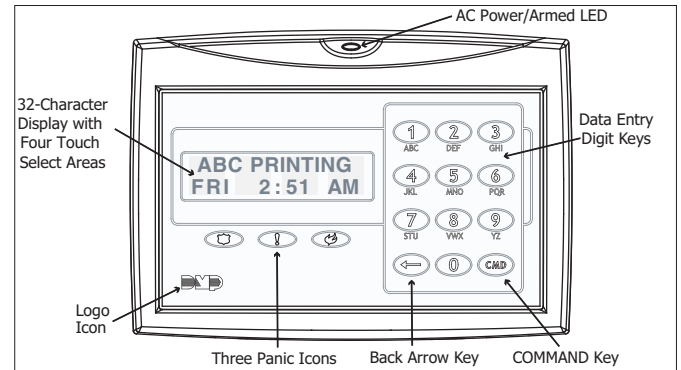

**Clear Touch™ Keypad**

## The Select keys

### Thinline™, Aqualite™, Icon and Wireless Keypads:

There are four keys under the display called the Select keys. These keys are one of the features that make your system so easy to operate. They allow you to make selections by pressing the Select key under a choice shown in the display.

**Note:** For the purposes of this guide, when instructed to press the first Select key, press the far left Select key; the second Select key is the second from the left; third Select key is second from the right; and the fourth Select key is the far right key.

### Clear Touch™ Keypads:

There are four Select Areas in the display. These Select Areas are one of the features that make your system so easy to operate. They allow you to make selections by touching the area to choose the item in the display.

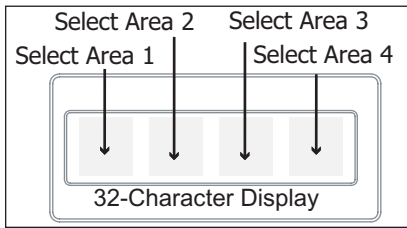

Touch Select Areas

**Note:** For the purposes of this guide when using Clear Touch™ Keypads, when instructed to press the first Select key, touch Select Area 1; the second Select key touch Select Area 2; third Select key touch Select Area 3; and the fourth Select key touch Select Area 4.

## Power/Armed LED

### Thinline™, and Aqualite™ Keypads:

The Power LED indicates the panel Power status. It is recommended you contact the service department when the Power LED is off or blinks.

LED Operation	AC	Battery
ON (Steady)	OK	OK
OFF	Trouble	N/A
BLINKS	OK	Trouble

The Armed LED is ON steady anytime any burglary protection area is armed and is OFF when ALL areas are disarmed.

### Clear Touch™ Keypads:

The LED indicates the Power and Armed status of the panel. Depending on the operation, the LED displays in Red or Blue as listed in the table.

Color and Activity	LED Operation
Blue Steady	Panel Disarmed, AC Power OK, Battery OK
Blue Blinking	Panel Disarmed, AC Power OK, Battery Fault
No Light	Panel Disarmed, AC Power Fault, Battery OK
Red Steady	Panel Armed, AC Power OK, Battery OK
Red/Blue Alternate	Panel Armed, AC Power OK, Battery Fault
Red Blinking	Panel Armed, AC Power Fault, Battery OK



## Power/Armed Logo

### Thinline™ Wireless Keypads:

The backlit logo on the keypad indicates the keypad Power status and Armed status of the panel. Depending on the operation, the logo displays Red or Green as listed in the table.

Color and Activity	Armed Status	Keypad Power Status
Green Steady	Panel Disarmed	AC Power OK, Battery OK
Green Blinking	Panel Disarmed	AC Power OK, Battery Fault
No Light	Panel Disarmed	AC Power Fault, Battery OK
Red Steady	Panel Armed	AC Power OK, Battery OK
Red/Green Alternate	Panel Armed	AC Power OK, Battery Fault
Red Blinking	Panel Armed	AC Power Fault, Battery OK

## Panic Functions

Your keypad may be set up to send a Panic, Emergency, or Fire report to the central station. This function is optional. If this option is programmed for your keypad, icons display below the top row Select keys/areas.

### Thinline™, Aqualite™, Icon and Wireless Keypads:

Press and hold the two Select keys adjacent to the desired icon for 2 seconds, until a beep from the keypad is heard.

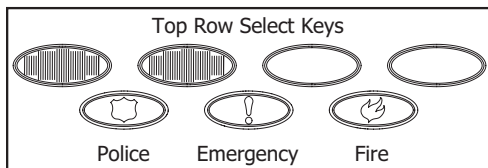

Thinline™/Aqualite™/Thinline™ Icon Keypad Panic Keys  
With Shaded Buttons To Indicate Police Panic Keys

### Clear Touch™ Keypads:

Touch the icon for 2 seconds until a beep is heard.

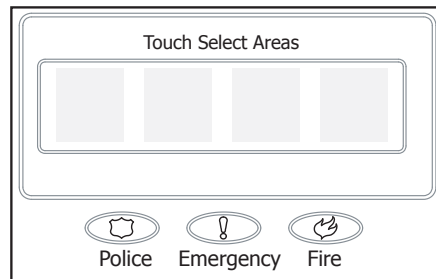

Clear Touch™ Keypad Panic Icons

## 7/0 Panic Function

### Thinline™, and Aqualite™ Keypads:

Security Command™, Thinline™, and Aqualite™ Keypads may also be programmed at installation to allow the user to initiate an optional Panic alarm by simultaneously pressing and holding the 7 and 0 (zero) keys. When the 7 and 0 keys are pressed for a short time, the keypad sends a Panic alarm report to the central station.

**Note:** The 7/0 Panic Function is not available on Clear Touch™ or Thinline™ Icon or Wireless keypads.

## Common Keys on All Keypads

### Data Entry Digit keys

These keys allow you to enter your user code when arming or disarming or enter other information into the system.

### COMMAND (CMD) key

The COMMAND key allows you to advance through the keypad displays, User Menu, or complete a data entry function.

### Back Arrow (←) key

The Back Arrow (←) key is used to go back through the keypad displays while operating your system. You can press the Back Arrow key to back up through the list of functions in the User Menu or to erase the last character you entered.

## Keypad User Options

The User Options menu allows you to make adjustments to your keypad to best fit your environment and needs.

**Thinline™, Aqualite™, Icon and Wireless Keypads:** Press and hold the Back Arrow and COMMAND keys for two seconds. The keypad display changes to SET BRIGHTNESS. Press the COMMAND key to display the next option or the Back Arrow key to exit.

**Clear Touch™ Keypads:** Touch and hold the center of the logo icon for two seconds. The display changes to SET BRIGHTNESS. Touch the COMMAND (CMD) key to display the next option or touch the Back Arrow (←) to exit the User Options function.

## Backlighting Brightness

At the SET BRIGHTNESS display, use the left Select key to lower the keypad brightness. Use the right Select key to increase the brightness. On Thinline™ Icon Series keypads, enter the desired brightness from the range of off (0) to maximum (8).

**Note:** If the brightness level is lowered, it temporarily reverts back to maximum intensity whenever a key is pressed.

**On Thinline™, or Aqualite™ Keypads:** This sets the LCD display, AC LED, and keyboard backlighting brightness level.

**Clear Touch™ Keypads:** The user selected brightness may be set to off which allows the backlighting to turn off (clear glass). Simply touch the glass anywhere and the backlight illuminates for data entry. When the speaker is sounding, the backlight illuminates at one-half (1/2) brightness.

**Thinline™ Icon and Wireless Keypads:** This sets the LCD display, keyboard, and logo backlighting brightness level.

## Internal Speaker Tone

Set the tone of the keypad internal speaker. At the SET TONE display, use the top left Select key to make the tone lower. Use the right Select key to make the tone higher. On Thinline™ Icon Series keypads, enter the desired speaker tone from the range of 1-8.

## Volume level

Set the volume level of the keypad internal speaker for key presses. During alarm, trouble, and prewarn conditions, the volume is always at maximum level. At SET VOLUME LEVEL, use the left Select key to lower the keypad volume. Use the right Select key to raise the volume. On Thinline™ Icon Series keypads, enter the desired speaker volume level from the range of off (0) to maximum (8).

## Model Number

### Thinline™, Aqualite™, Icon Keypads:

The keypad model number, firmware version/date display.

## Serial Number

### Thinline™ Wireless Keypads:

The serial number assigned to the keypad displays. Press the Back Arrow key to exit the User Options function.

## Keypad Address

The current address assigned to the keypad displays, but cannot be changed. Press the Back Arrow key to exit the User Options function.

## Special Keypad Tones

Your keypad also contains a small speaker that alerts you about events as they occur on your system. For burglary alarms, the tone will silence as soon as the first user code digit key is pressed. If a valid user code is not entered within 5 seconds or an invalid user code is entered, the tone begins sounding again.

Below are brief descriptions of the different tones you hear from the keypad.

**Fire alert:** An intermittent sweeping siren from LCD keypads only that continuously repeats until the fire alarm is silenced. This is in addition to the bell output from the alarm panel.

**Burglary alert:** A siren tone from LCD keypads only that continues until the alarm is silenced. This is in addition to the bell output from the alarm panel.

**Key press tone:** A short beep as you press a key on the keypad.

**Prewarn tone:** A continuous pulsed tone that sounds when you open an entry delay door on a system that is armed (turned on) reminding you to disarm the burglary protection.

Your system will silence the tone as soon as the first user code digit key is pressed. If a valid user code is not entered within 5 seconds or an invalid user code is entered, the prewarn tone begins sounding again.

**Exit tone:** When fully arming your system to leave, a continuous pulsing tone sounds during the exit countdown just after arming to remind you to exit the premise. At ten seconds prior to the end of the countdown, the rate of pulsing increases.

**Monitor tone:** A pulsed tone that sounds one time for one second each time a door or window is opened while you are using the zone monitor function from the User Menu. See Zone Monitor.

**Trouble tone:** A steady tone indicating a trouble condition on your system. Press any key to silence the trouble tone.

### **What to do when the trouble tone sounds**

You can silence the trouble tone by pressing any key. This only silences the keypad and does not correct the condition that originally caused the trouble.

## 1100 Series Wireless

Your system may include wireless devices such as key fob(s). There are three types of wireless key fobs available:

- 4-Button Model 1145 Key Fob
- 2-Button Model 1146 Key Fob
- 1-Button Model 1147 Key Fob

The drawing shows the button layout for all three models for your reference. Each button on the key fob is programmed to perform a specific action. The button names are listed for your reference.

- TOP = the Key Fob Top button
- BTM = the Key Fob Bottom button
- LFT = the Key Fob Left button
- RGF = the Key Fob Right button

The button programming list for the key fob(s) connected to your system is located in the System Setup section of this guide. Refer to Appendix B for LED Status operation information. Specific function labels can be added to each button to indicate button operation.

For best operation, allow the LED to turn on and then turn off before pressing another button. The key fob may not complete sending the signal for the button press if another button is pressed too soon.

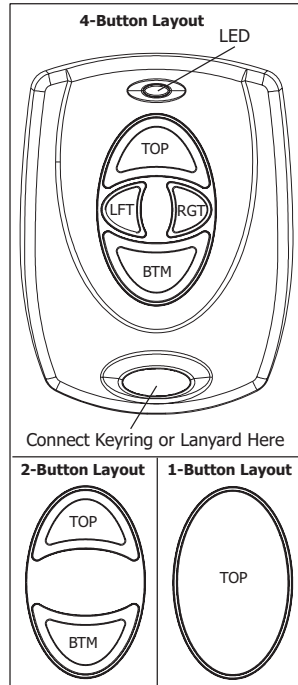

Key Fob Examples and Button Names

## Special Wireless Displays

Your system may use wireless transmitters to send alarm and trouble information from the protection devices to the panel. Wireless systems have a few unique keypad displays.

**BACK DOOR -LOBAT** - (Low Battery) The battery in a wireless transmitter is low. (BACK DOOR is used as an example only.)

**BACK DOOR -MISNG** - (Missing) The panel is not receiving the wireless transmitter periodic test report.

**WIRELESS -TRBL** - (Trouble) Some part of your wireless system is operating improperly. Call the service department for assistance.

**WIRELESS RECEIVER JAMMED -ALARM** - Your system may be programmed for wireless interference detection and, if displayed, your wireless receiver has detected an interfering signal while the system is armed.

**WIRELESS RECEIVER JAMMED -TRBL** - (Trouble) Your system may be programmed for wireless interference detection and, if displayed, your wireless receiver has detected an interfering signal while the system is disarmed.

## Special Keypad Displays

As you use your system, you may occasionally see a keypad display that asks you to enter a user code or describes a condition on the system. Below are some examples of the displays you may see.

### ALARM

A 24-hour zone, such as a fire or panic zone, or an armed burglary zone is faulted. Your system may sound bells or sirens.

### ALARM NOT SENT

The alarm signal was aborted and was not sent to the central station because a user code was entered to disarm the system before the alarm signal was sent to the central station. Also, your system may be pre-programmed at installation to send an Abort signal to the Central Station. Refer to the Introduction section.

## **ALARM CANCELLED**

An Alarm signal just sent to the central station was cancelled because a user code was entered after the alarm was sent. Also, an Alarm Cancel signal is sent to the Central Station.

## **ALARM VERIFIED**

A valid burglar alarm has occurred and has been manually verified by the user. The alarm system also transmits a VERIFY message to the Central Station.

## **ENTER CODE**

The system requires you to enter a personal user code. User codes can be used for turning your system on (arming), turning your system off (disarming), and other system options.

As you enter your user code, the keypad display shows an asterisk (\*) in place of each digit pressed. This prevents others from seeing your user code on the display as you enter it.

## **TRY AGAIN or INVALID CODE**

The code entered is not recognized by the system. Check the user code and try again.

## **TRBL (TROUBLE)**

There is a problem with a protection device or system component. This display is accompanied by a description of the problem.

## **SYSTEM TROUBLE or SERVICE REQUIRED**

There is an electronic failure in your system. Contact the service department as soon as possible.

## **TEST IN PROGRESS**

The system is currently being tested by an installation or service technician.

## **Email/Cell Phone Messages**

Your system may be programmed at installation to send a variety of messages to your personal email, and cell phone.

The message option uses your security system's reporting capability to send reports using an email address or cell phone number in much the same way as someone sending an email would do. You can receive reports of alarms, troubles, or system armings and disarmings and know at a glance your system status. See Appendix D for more information.

## **MyAccess™ Text Messaging Commands**

Your system may be programmed to allow simple text messages to be sent to the security system and perform basic user operations. By texting a message from your cell phone or PDA, the following actions can be performed: Arm/Disarm, check Armed Status, Cancel Alarm, and turn Outputs On/Off. Other operations that may be programmed from your cell phone or PDA include: Turning on and off lights, Locking and unlocking doors, and Setting the thermostat. See Appendix D for more information.

## **Understanding Security System Terms**

Throughout this guide, and in some displays on your keypad, you may see certain words or phrases that might be unfamiliar.

Below are some terms you will see here and on the keypad display.

### **Arming**

This is the term used for turning on the burglary protection in one or more areas of the system. Your system may require you to enter a user code. When armed, the system can sound alarm bells or sirens and, if monitored, send alarm reports to a central station when a burglary zone is faulted.

Fire, panic, and other 24-hour devices are always turned on and do not need to be armed.

## **Disarming**

This means turning off one or more areas of the system. When disarmed, the system does NOT sound alarms or send alarm reports to a central station when a burglary zone faults.

## **Zone**

A zone refers to one or more protected openings or protection devices assigned the same zone number. Each door or window, motion detector, smoke detector, or other device has a zone number and a name.

Often, similar devices in the same general area share the same zone. For example, the windows on the east side of the premises can all be grouped together in a zone named E. WINDOWS.

## **Entry or Exit Zone**

Almost all systems have one or more doors through which you can enter or exit the premises. These doors are programmed with a delay time to allow you to enter or exit while the system is armed without setting off the alarm.

When you arm the system, activity on all burglary zones is ignored until the programmed exit delay time expires. Once that time has expired and the system is fully armed, opening the door causes the panel to start the entry delay time. During the entry delay time, enter a valid user code to disarm the system or an alarm occurs.

## **Instant Zone**

Exterior windows and non-entry doors, or interior protection devices, are typically not programmed with delay times. If these zones fault while the system is armed, an alarm occurs instantly.

## **24-Hour Zone**

A 24-hour zone is not turned on or off by arming or disarming your system. Some examples of 24-hour zones are fire zones, panic zones, and temperature control zones.

## **Areas**

An area is made up of burglary zones that can be armed or disarmed together. The Perimeter area, for example, consists of all the doors and windows on the outside of the building. When you arm the Perimeter, these zones sound an alarm if tripped.

## **Central Station Monitoring**

Your system can also be programmed to automatically send alarm, trouble, and arming and disarming reports to a central station. Operators at the central station can then dispatch the appropriate authorities or contact you with the specific event information.

## **Status**

Status is a feature that automatically displays the system armed or disarmed status on the keypads. Alarm or trouble conditions on a zone or a system monitor such as AC or battery trouble can also display. There are two types of status information available: **Status List** and **Armed Status**.

### **Status List**

The keypad Status List displays any alarm or trouble condition on a zone and any trouble condition that occurs with the AC power or battery power. If your system contains any Panic zones, these do not display on the keypad for security reasons.

If an alarm occurs on a non-fire, 24-hour zone or a system monitor, it remains in the Status List until it restores. If one or more armed burglary zones trips, the last one to trip remains in the Status List. The burglary zone alarm remains in the Status List until it is cleared by disarming the system.

### **Zone Status**

To display the status of a particular zone, enter the zone number followed by the COMMAND key when the keypad displays the Status List.

## **Armed Status**

With Armed Status, the keypad displays the current armed condition of areas within your security system.

<b>The keypad displays</b>	<b>When</b>
<b>HOME SYSTEM ON</b>	The perimeter areas is armed in a Home/Away system.
<b>PERIMETER ON</b>	The perimeter is armed in an All/Perimeter system.
<b>ALL SYSTEM ON</b>	All areas are on.
<b>SLEEP SYSTEM ON</b>	The perimeter and interior areas are on but the bedroom area is off.

Also, for keypads that include an Armed LED, the Armed LED is ON steady anytime a burglary protection area is armed and OFF when ALL areas are disarmed.

## **Exit Error**

This is an automatic panel function that occurs if an exit door does not close all the way after the system is armed.

For example, if the front door is left ajar upon exit and the exit delay time expires, the system attempts to arm the front door zone but recognizes the open condition. The system sounds the alarm sirens and starts the entry delay. If the open condition is not corrected, an alarm and exit error is reported to the central station.

The Exit Error feature allows the central station to acknowledge the arming error without dispatching the police on a false alarm.

# Arming and Disarming

## How Your System Operates

Your system has been programmed to operate in one of three modes: Area, All/Perimeter or Home/Sleep/Away.

- **Area** – Your burglary protection is divided into up to six areas. Each area can have a custom name, be turned on or off independently of other areas, and limit access to only those users with proper authority.
- **All/Perimeter** – Your burglary protection is divided into two areas: Interior and Perimeter.

**Perimeter** arming is for when you are staying inside but want the comfort of knowing the exterior doors and windows are armed. Perimeter arming allows you to move freely about inside without setting off any interior alarms.

**All** arms both the Perimeter and the Interior of the system. You want to arm both of these areas when leaving the building and no one is left inside.

- **Home/Sleep/Away** – Your burglary protection is divided into two or three areas: Perimeter, Interior, and Bedrooms.

**Home** (Perimeter) arming is for when you are staying inside but want the comfort of knowing the exterior doors and windows are armed.

**Sleep** (Perimeter and Interior) arms all areas except those near bedrooms and nighttime areas.

**Away** (Perimeter, Interior, and Bedrooms) arms all three areas for when you leave the building and no one is left inside.

Regardless of which mode is programmed, much of the operation is similar. Throughout this guide, any differences between the systems are noted for your convenience.

## Arming Functions

**Arming:** During arming, the system verifies that all doors, windows, and other protection devices to be armed are in normal condition. If everything is normal, the system arms. If there is a problem on one or more burglary zones, the keypad displays the problem and allows you to correct the problem or bypass those zones.

If the problem can be corrected by closing a door or window, do not bypass the zone. Instead, correct the problem and try arming again. If the problem cannot be corrected, you can bypass the zone or wait until the zone can be repaired by a service technician. A bypassed zone is ignored by the system during the armed period.

In some cases the keypad might display **FRONT DOOR - FAULT**. The keypad may then display **PRIORITY ZONE**, which is a zone that cannot be bypassed. The problem on the zone must be corrected before the system can be armed.

After making your arming selection, the keypad displays any zones that are currently bypassed. These zones remain bypassed until the system is armed and then disarmed. Any 24-hour zones in a faulted condition also display.

**Armed Message:** After completing all bypasses or correcting zone faults, the areas selected are armed.

For All/Perimeter systems the keypad briefly displays **ALL SYSTEM ON** if all areas in the system are arming or **PERIMETER ON** if only selected areas are arming.

For Home/Away or Home/Sleep/Away systems the keypad displays **ALL SYSTEM ON** if all areas in the system are arming, **HOME SYSTEM ON** or **SLEEP SYSTEM ON** if only selected areas are arming.



**Exit Delay:** The keypad then displays the exit delay time as it counts down. If the entire system has been armed, your system beeps the exit delay tone at eight-second intervals until the last 10 seconds when the keypad beeps at three-second intervals. After exiting the building, if you re-enter during the countdown the exit countdown restarts, allowing additional time to then disarm or again exit the building during the countdown. This restart can occur only one time. When the exit delay time expires, all disarmed zones are armed. If your system uses a keyswitch to arm an area, the exit delay time does NOT count down on the keypad display.

When you arm both the Perimeter and Interior to leave the building but then you do not exit by the time the exit delay ends, the system automatically arms but the interior area(s) will remain disarmed because you have not exited.

Should you exit the building and the door does not close properly, your system may be programmed so that when the exit delay countdown ends, then the entry delay starts and the bell will sound to alert you to the situation. Enter your user code to stop the bell and disarm the system. Rearm the system, exit the building, and make sure the door is securely closed.

**ONE MOMENT . . . Message:** If your system is monitored, it may be programmed to wait for the arming report to be sent to the monitoring station before displaying the armed message. (See Arming Report below.) This verifies that the arming message was received by your monitoring station. While the system waits, the display reads **ONE MOMENT....** If the report is received, the keypad buzzes for one second and displays the armed message. If the report is not received, the keypad displays **LOCAL ALARM ONLY** before displaying the armed message.

**Arming Report:** Your system may be pre-programmed at installation to send arming or zone bypass reports to a central station.

## **Key Fob Arming**

Press the key fob button programmed for Arming or Toggle (Arm/Disarm) button. A Red LED two-second acknowledgement indicates All System On. A Green/Red two-second acknowledgement indicates System On with some areas armed.

## **Key Fob Disarming**

Press the key fob button programmed for Disarming or Toggle (Arm/Disarm) button. A Green LED two-second acknowledgement indicates All System Off.

## **Area System Arming**

**Area Assignment:** Your security system is programmed into separate areas. The number of areas and their names are listed in the back of this guide.

**Arming or Disarming:** You can arm and disarm all areas at one time or each area individually. You can only arm or disarm areas authorized for your user code.

**All or Selective Arming:** After entering your user code, the system allows you to arm either all of the areas to which you have access or one or more selected areas. If you choose to arm all areas, the system begins verifying that all zones in those areas are in a good condition. If you choose to arm selected areas, the system prompts you to choose the areas you want to arm.

## Arming the System

1. Press the **COMMAND** key until **ARM DISARM** displays.
2. Select **ARM** to turn on all protection.
3. Enter your user code if required. The display reads **ALL? NO YES**.
4. Select **NO** to arm only selected areas. Go to step 5. Select **YES** to arm all areas authorized for your user code.
5. If **NO** is selected in step 4, the display begins to list each area to which you have access followed by **NO YES**. Example: **OFFICE NO YES**.
  - 5a. Select **YES** for each area you want to arm.
  - 5b. Select **NO** for each area you do NOT want to arm.

**Note:** You can also simply press the area numbers you want to arm while **ALL? NO YES** displays. This changes the display to **AREAS:.** The numbers you select appear in the display. For example: **AREAS: 2 4**. Press **COMMAND** when done.
6. The system displays any faulted and bypassed zones in the following order: faulted burglary zones, bypassed burglary zones, faulted 24-hour zones, and bypassed 24-hour zones.
7. At this point you can **force arm** or **bypass** any faulted burglary zones. A zone that is force armed is restored into the system if it later returns to normal. A zone that is bypassed remains bypassed until the system is disarmed. See steps 7a through 7d.
  - 7a. If a problem exists on any zones, the zone name and problem are shown followed by: **OKAY BYPASS STOP**.
  - 7b. Select **OKAY** to force arm the zone(s) before arming.
  - 7c. Select **BYPASS** to bypass the zone(s) before arming.

**Note:** 24-hour zones cannot be bypassed.
  - 7d. Select **STOP** to stop the system from arming. Correct the zone problem(s) and return to step 1.
8. The display reads **SYSTEM ON** if at least one area in the

system is armed, and **ALL SYSTEM ON** if all areas in the system are armed.

9. The keypad then displays the exit time in seconds and counts down the remaining time: **EXIT: # # (# # = seconds remaining)**. When the entire system is armed, the keypad sounds the exit delay alert and when the delay expires, all zones are armed.

## Area System Disarming

**Disarming:** While the system is armed, you can only enter the premises through an exit/entry delay door without causing an alarm. After opening the door, the keypad sounds a prewarn tone to remind you to disarm the system. You must disarm the system before the delay time expires or an alarm on the door zone occurs.

During the prewarn tone, the keypad displays **ENTER CODE:** Enter your user code to disarm the system. Only those areas authorized for your user code disarm.

**Note:** Your system will silence the tone as soon as the first user code digit key is pressed. If a valid user code is not entered within 5 seconds or an invalid user code is entered, the prewarn tone begins sounding again.

**All or Selective Disarming:** After entering your user code, the system allows you to disarm either all of the areas to which you have access or just selected areas. If you choose to disarm all areas, the system automatically disarms them. If you choose to disarm selected areas, the names of those areas display on the keypad.

**Z-Wave Lock Disarming:** If your system is installed with a Z-Wave compatible lock, a valid user code entered at the lock will unlock the door and disarm the areas to which you have access.

**Alarm Display:** After disarming, the keypad displays any zones that went into alarm or any communication problems that occurred during the armed period. All burglary zones are then disarmed and any bypassed zones are automatically reset.

**Disarmed Message:** The keypad displays **ALL SYSTEM OFF** after the system disarms.

**Central Station Report:** Your system may be pre-programmed at installation to send a report of the disarming to the central station.

### **Disarming an Area System**

1. Press the **COMMAND** key until **ARM DISARM** displays. During entry delay this process starts at step 3 below.
2. Select **DISARM** to disarm areas.
3. The keypad displays **ENTER CODE:** . Enter your user code and press **COMMAND**. The keypad displays **ALL? NO YES**.
4. Select **YES** to disarm all areas authorized for your user code.
  - 4a. Select **NO** to disarm only certain areas individually. The keypad then displays the name of each area authorized for your code followed by the **NO YES** display.
  - 4b. Select **YES** to disarm the area displayed.
  - 4c. Select **NO** to not disarm and to display the next area.

**Note:** You can also just press the area numbers you want to disarm while at the **ALL? NO YES** display. This changes the display to **AREAS:** . The area numbers you select appear in the display. For example: **AREAS: 2 4**.

To remove an area number from the display, press its corresponding number on the keypad. Press **COMMAND** when done.

5. After all areas have displayed, any alarms or communication problems that occurred during the armed period are shown.
6. If all areas are disarmed, the keypad displays **ALL SYSTEM OFF**.

### **All/Perimeter System Arming**

**Area Assignment:** Your security system is divided into two separate areas. Motion detectors, inside doors, and other interior protection devices are assigned to the *Interior* area while windows and exterior doors are assigned to the *Perimeter* area.

**Perimeter or All:** When arming an All/Perimeter system, the keypad displays **PERIM ALL**. If you select **ALL**, you arm both the Perimeter and the Interior of the system. You want to arm both of these areas when leaving with nobody left inside. Selecting **PERIM** arms only the Perimeter of the system. Perimeter arming is for when you are staying inside but want the comfort of knowing the exterior doors and windows are armed. Perimeter arming allows you to move freely about inside without setting off any interior alarms.

### **System Ready/System Not Ready Keypad Displays**

When all zones in the system are in a normal condition, the keypad displays **SYSTEM READY**. If there are one or more zones that are not in a normal condition, the keypad displays **SYSTEM NOT READY**. Pressing any Select key during this display shows the zone name allowing you to investigate the problem.

### **Instant Arming**

**Instant:** During the exit delay time, you can cancel the exit and entry delays and cause all zones to be instant zones. Select **INSTNT** while the exit delay displays. This immediately arms the exit zones. However, no entry delay is provided and an alarm immediately occurs should an entry door be opened.

### **All/Perimeter Shortcut Key Arming**

**Arm Perimeter** — Press 6 for 2 seconds.

**Arm All**— Press 1 for 2 seconds.

## Arming an All/Perimeter System

1. Enter your code. The keypad displays **PERIM ALL**.
2. Select **PERIM** to arm the Perimeter area only.
3. Select **ALL** to arm both the Perimeter and Interior areas.
4. The system displays any faulted and bypassed zones in the following order: faulted burglary zones, bypassed burglary zones, faulted 24-hour zones, and bypassed 24-hour zones.
5. At this point you can **force arm** or **bypass** any faulted burglary zones. A zone that is force armed is restored into the system if it later returns to normal. A bypassed zone remains bypassed until the system is disarmed. See steps 5a through 5d.
  - 5a. If a problem exists on any zones, the zone name and problem display followed by: **OKAY BYPASS STOP**.
  - 5b. Select **OKAY** to force arm the zone(s) before arming.
  - 5c. Select **BYPASS** to bypass the zone(s) before arming.
  - 5d. Select **STOP** to stop the system from arming. Correct the zone problem(s) and return to step 1.
6. The keypad displays **PERIMETER ON** if only the perimeter is being armed and **ALL SYSTEM ON** if both the perimeter and interior are being armed.
7. The keypad next displays **EXIT: ## INSTNT** and begins to count down the number of seconds remaining for you to exit. If the entire system is armed, the keypad sounds the exit delay alert and when the delay expires, all zones are armed.
8. You can select **INSTNT** while **EXIT: ## INSTNT** displays to immediately arm all zones and make them instant. The keypad displays **INSTANT**. When you select **INSTANT**, any entry/exit zone that trips immediately activates an alarm and the exit delay countdown immediately stops.

9. When the system is armed, the keypad displays **PERIMETER ON** for perimeter arming and **ALL SYSTEM ON** for perimeter and interior arming.

## All/Perimeter System Disarming

**Disarming:** While the system is armed, you can only enter the premises through an entry/exit delay door without causing an alarm. After opening the door, the keypad sounds a prewarn tone to remind you to disarm the system. You must disarm the system before the prewarn tone expires or an alarm on the door zone occurs.

During the prewarn tone, the keypad displays **ENTER CODE:.** Enter your user code to disarm the system.

**Note:** Your system will silence the tone as soon as the first user code digit key is pressed. If a valid user code is not entered within 5 seconds or an invalid user code is entered, the prewarn tone begins sounding again.

**Alarm Display:** After disarming, the keypad displays any zones that tripped or any transmission problems that occurred during the armed period. All burglary zones are then disarmed and any bypassed zones automatically reset.

**Disarmed Message:** The keypad displays **ALL SYSTEM OFF** after the system disarms.

**Central Station Report:** Your system may be pre-programmed at installation to send a report of the system disarming to the central station.

**Z-Wave Lock Disarming:** If your system is installed with a Z-Wave compatible lock, a valid user code entered at the lock will unlock the door and disarm the system.

## Disarming an All/Perimeter System

1. During the entry delay time, the keypad displays **ENTER CODE:.** Enter your user code.
2. The keypad displays any zones that went into alarm and any communication problems that occurred during the armed period.
3. The keypad next displays **ALL SYSTEM OFF** to confirm the system is disarmed.

## Disarming During an Alarm

1. While the alarm bell or siren sounds, you may choose to enter your user code to silence the alarm sounder.

For a burglary alarm, the keypad displays

**CANCEL VERIFY**

and after the pre-programmed alarm communication delay, the alarm is sent to the Central Station.

This allows you to investigate the alarm prior to disarming the system. This display remains on the keypad until a selection is made, the Back Arrow is pressed, or the internal system bell cutoff timer expires.

2. If a valid alarm has not occurred, Select **CANCEL** to disarm the system and cancel the alarm.

The keypad displays **ALARM CANCELLED** then **ALL SYSTEM OFF** to confirm the system is disarmed.

OR

If the alarm is valid, select **VERIFY** to send a verify message to the Central Station.

## Home/Away System Arming

**Area Assignment:** Your security system is divided into two or three separate areas. Motion detectors, inside doors, and other interior devices are assigned to an Interior and possibly Bedroom area while windows and exterior doors, are assigned to a Perimeter area.

**Arming the system:** When arming a Home/Away system, the keypad displays **HOME AWAY** or **HOME SLEEP AWAY**. If you select **AWAY**, you arm all areas of the system. You want to arm all areas when leaving with nobody staying inside.

Selecting **HOME** arms only the system Perimeter. Perimeter arming is for when you are staying inside but want the comfort of knowing the exterior doors and windows are armed.

Selecting **SLEEP** arms the Perimeter and Interior devices but leaves devices near bedrooms and other nighttime areas off.

## System Ready/System Not Ready Keypad Displays

When all system zones are in a normal condition and can be armed without bypassing, the keypad displays **SYSTEM READY**. If there are one or more zones that are not in a normal condition, the keypad displays **SYSTEM NOT READY**. Pressing any Select key during this display shows the faulted zone name.

## Home/Sleep/Away Shortcut Key Arming

**Arm Home** — Press 3 for 2 seconds to arm the perimeter.

**Arm Sleep** — Press 7 for 2 seconds to arm the perimeter and interior areas and leave the bedroom area off.

**Arm Away** — Press 1 for 2 seconds.

## Arming a Home/Away System

1. Enter your user code. The keypad displays **HOME AWAY** or **HOME SLEEP AWAY** (you may have three areas).
2. Select **HOME** to arm the Perimeter only.
3. Select **SLEEP** to arm the Perimeter and Interior.
4. Select **AWAY** to arm the Perimeter, Interior, and Bedroom.
5. The system displays any faulted and bypassed zones in the following order: faulted burglary zones, bypassed burglary zones, faulted 24-hour zones, and bypassed 24-hour zones.
6. At this point you can force arm or bypass any faulted burglary zones. A zone that is force armed is restored into the system if it later returns to normal. A zone that is bypassed remains bypassed until the system is disarmed. See steps 6a through 6d.
  - 6a. If a problem exists on any zones, the zone name and problem display followed by: **OKAY BYPASS STOP**.
  - 6b. Select **OKAY** to force arm the zone(s) before arming.
  - 6c. Select **BYPASS** to bypass the zone(s) before arming.
  - 6d. Select **STOP** to stop the system from arming. Correct the zone problem(s) and return to step 1.
7. The keypad displays **HOME SYSTEM ON** if you selected **HOME**, or **SLEEP SYSTEM ON** if you selected **SLEEP**, or **ALL SYSTEM ON** if you selected **AWAY**.
8. The keypad next displays **EXIT: ## INSTNT** and begins to count down the number of seconds remaining for you to exit. The keypad sounds the exit delay alert and when the delay expires, all zones are armed.
9. You can select **INSTNT** while **EXIT: ## INSTNT** displays to immediately arm all zones and make them instant. The keypad displays **INSTANT**. When you select **INSTANT**, any entry/exit zone that trips immediately activates an alarm and the exit delay countdown immediately stops.

10. When the system is armed, the keypad displays **HOME SYSTEM ON** for Perimeter arming, **SLEEP SYSTEM ON** for Perimeter and Interior arming, and **ALL SYSTEM ON** for all areas armed.

## Home/Away System Disarming

**Disarming:** While the system is armed, you can only enter the premises through an entry/exit delay door without causing an alarm. After opening the door, the keypad sounds a prewarn tone to remind you to disarm the system. You must disarm the system before the prewarn tone expires or an alarm on the door occurs.

During the prewarn tone, the keypad displays **ENTER CODE:.** Enter your code to disarm the system.

**Note:** Your system will silence the tone as soon as the first user code digit key is pressed. If a valid user code is not entered within 5 seconds or an invalid user code is entered, the prewarn tone begins sounding again.

**Alarm Display:** After disarming, the keypad displays any zones that tripped or any communication problems that occurred during the armed period. All burglary zones are then disarmed and any bypassed zones automatically reset.

**Disarmed Message:** The keypad displays **ALL SYSTEM OFF** after the system disarms.

**Central Station Report:** Your system may be pre-programmed at installation to send a report of the system disarming to the central station and/or to your email address or cell phone.

**Z-Wave Lock Disarming:** If your system is installed with a Z-Wave compatible lock, a valid user code entered at the lock will unlock the door and disarm the system.

## Disarming a Home/Away System

1. During entry delay, the keypad displays **ENTER CODE:.** Enter your user code.
2. The keypad then displays any alarms or communication problems that occurred during the armed period.
3. The keypad next displays **ALL SYSTEM OFF** to confirm the system is disarmed.

## Disarming During an Alarm

1. While the alarm bell or siren sounds, you may choose to enter your user code to silence the alarm sounder.  
For a burglary alarm, the keypad displays **CANCEL VERIFY** and after the pre-programmed alarm communication delay, the alarm is sent to the Central Station.

This allows you to investigate the alarm prior to disarming the system. This display remains on the keypad until a selection is made, the Back Arrow is pressed, or the internal system bell cutoff timer expires.

2. If a valid alarm has not occurred, Select **CANCEL** to disarm the system and cancel the alarm.  
The keypad displays **ALARM CANCELLED** then **ALL SYSTEM OFF** to confirm the system is disarmed.  
**OR**  
If the alarm is valid, select **VERIFY** to send a verify message to the Central Station.

## Keypad Shortcut Keys

Your LCD keypad provides one-button shortcut keys. Holding down the selected keypad button for two seconds until the tone re-sounds allows you to arm, monitor, or reset your system. These options can still be accessed through the User Menu if desired.

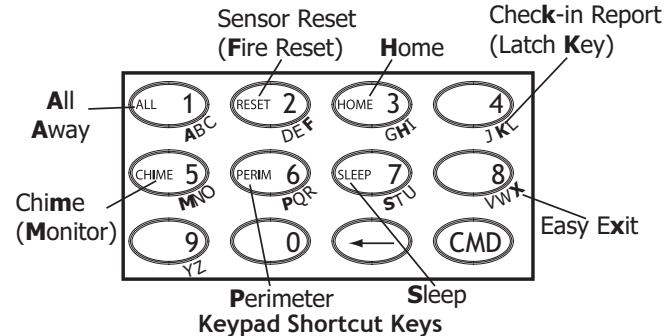

### Keypad Key

Press Key 1

Press Key 2

Press Key 3

Press Key 4

Press Key 5

Press Key 6

Press Key 7

Press Key 8

### Arming System Operation

Arm Away for Home/Sleep/Away systems

Arm All for All/Perimeter systems

Sensor (Fire) Reset on all systems

Arm Home for Home/Sleep/Away systems

Check-in Report on all systems

Monitor (Chime) on all systems

Arm Perimeter for All/Perimeter systems

Arm Sleep for Home/Sleep/Away systems

Easy Exit for Home/Sleep/Away systems



## Arming Function

**System Operation:** Home/Sleep/Away, or All/Perimeter.

You can use the Arming shortcut keys, 1, 3, 6, and 7 when the system is disarmed. You may be prompted to enter your user code. If any zones are faulted, select force arm or bypass. Refer to the Arming Section for detailed arming operation.

### Home/Sleep/Away Arming

**Arm Home** — Press 3 for 2 seconds to arm the perimeter.

**Arm Sleep** — Press 7 for 2 seconds to arm the perimeter and interior areas and leave the bedroom area off. This shortcut key is available when the system is disarmed and when the system is armed for Home mode.

**Arm Away** — Press 1 for 2 seconds.

### All/Perimeter Arming

**Arm Perimeter** — Press 6 for 2 seconds.

**Arm All**— Press 1 for 2 seconds.

## Sensor (Fire) Reset Function

**System Operation:** Area, Home/Sleep/Away, or All/Perimeter.

You can use the Sensor (Fire) Reset, shortcut key 2, when the system is armed or disarmed. When pressed, detectors that have latched due to an alarm condition are now restored and returned to normal function. The keypad displays SENSORS ON and SENSORS OFF to acknowledge the shortcut key press.

**Note:** You are prompted to enter your User Code on Area or All/Perimeter systems.

## Monitor (Chime) Function

**System Operation:** Area, Home/Sleep/Away, or All/Perimeter.

You can use the Monitor (Chime), shortcut key 5, when the system is disarmed. When pressed, the Zone Monitor operation is initiated. As needed, refer to the Zone Monitor section. The keypad displays **MONITOR ON** and chimes or displays **MONITOR OFF** and no tone is sounded.

**Note:** The Monitor (Chime) shortcut key applies to all Exit zones in an Area system and to all zones assigned to the perimeter in a Home/Sleep/Away or All/Perimeter system.

## Check-in Report (Latch Key) Function

**System Operation:** Area, Home/Sleep/Away, or All/Perimeter.

Your system may be pre-programmed at installation to send messages to your personal email, PDA, or cell phone. You can use the Check-in Report (Latch Key), shortcut key 4, to have a Check-in Report message sent. Refer to Appendix D for Email/Cell phone message information.

**Note:** Check-in report function is not supported by Icon keypads.

## Easy Exit™ Function

**System Operation:** Home/Sleep/Away.

You can use the Easy Exit, shortcut key 8, when the system is armed, to restart the exit delay allowing you to exit the premises without disarming the system. For example, to let a pet out or retrieve the newspaper. After the exit delay time expires, the system automatically rearms.

You can also press the Easy Exit, shortcut key 8 again, to cancel the exit delay countdown. For example, the telephone rings before you retrieve the newspaper so you press shortcut key 8 to rearm the system.



## User Menu

Many of your system features have been put into a User Menu that you can access from a 32-character keypad. The menu requires you to enter your user code. Only those functions to which you have access display.

### Accessing the User Menu

1. Press the COMMAND key until MENU? NO YES displays.
2. Select YES. The keypad displays ENTER CODE: — . Enter your user code. You can now scroll down through the list of system features available to you.

### User Menu Options

The following list shows the User Menu options in order:

Menu Option	Description
USER CHECKIN	Allows check-in with the system to indicate arrival on premises.
ZONE ACTIVITY CHECK	Allows you to monitor a zone for non-activity.
SENSOR RESET	Resets smoke or glassbreak detectors that have latched during an alarm condition.
OUTPUTS ON/OFF	Allows you to turn on or off any of the outputs described in the System Setup section of this guide.
FAVORITES	Allows you to activate any of the Favorites described in the System Setup section of this guide.
BYPASS ZONES	Allows you to Bypass a zone or reset an already bypassed zone.

### ZONE MONITOR

Allows you to add or remove a zone from the monitor mode.

### SYSTEM TEST

Tests the system siren, communication to the central station, and backup battery.

### USER CODES

Allows you to add, delete, or change user codes and authority levels.

### SCHEDULES

Allows you to add, remove, or change system schedules.

### DATE AND TIME

Allows you change the Day, Date, or Time that is currently in the system.

### DISPLAY EVENTS

Allows you to view the last 100 events on the XT30 and 200 events on the XT50 that occurred on your system.

### SERVICE REQUEST

Allows you to send a message to the Central Station requesting service on the alarm system.

The following pages detail each User Menu item and provide instructions on when and how to use them properly.

## User Check-in

**User Code Level:** Master, Standard, Limited, or Scheduled.

**Function:** This feature allows you to monitor the arrival of children from school or employees to work by having a special Check-in Report sent to your email address or cell phone if programmed.

**Note:** Check-in report function does not work with Icon keypads. Appendix D describes the Email/Cell Phone option.

### Sending a Check-in Report

1. After disarming the system, access the User Menu.
2. At the **USER CHECKIN?** display, press any Select key. The keypad displays **USER CHECKIN: 22** (22 = user number).
3. The panel sends the Check-in Report containing your account number and user number to the email address or cell phone number.

### Check-in (Latch Key) Report Shortcut Key

**All Systems (except Icon keypads)** – Press 4 for 2 seconds, then enter your user code to send a Check-in Report.

## Zone Activity Check

**User Code Level:** Master, Standard, Limited, or Scheduled.

**Function:** Your security system may be pre-programmed at installation for the Zone Activity Check feature allowing you to monitor a person for non-activity.

When no activity is detected for the programmed time period, your keypad sounds a steady tone for a set period of time and displays **PRESS ANY KEY**. Pressing any key on the keypad, before the steady tone stops, prevents your system from sending a “User Activity Not Detected” report to the central station. Pressing the key also restarts the zone activity timer.

This could be used for a person living alone to detect when they have not moved about to trip a disarmed zone within a programmed period of time. This feature is optional.

**Note:** The Zone Activity Check is disabled when a schedule is entered to allow for sleeping hours and is automatically enabled when an area is disarmed.

### Selecting Zone Activity Check

1. At the **ACTIVITY CHECK?** display, press any Select key. The keypad displays **ENABLE? YES NO**. The default is **YES**.
2. When **NO** is selected, the keypad displays **CHECK DISABLED** for four seconds and then sends the Activity Check Disabled message to the central station.
3. When **YES** is selected, the keypad displays **CHECK ENABLED** for four seconds and then sends the Activity Check Enabled message to the central station.

## Sensor Reset

**User Code Level:** Master, Standard, Limited, or Scheduled.

**Function:** Resets smoke or glassbreak detectors. Also clears Fire and Supervisory zone alarms and trouble keypad displays. Sensor Reset also clears low battery displays if your system is using wireless sensors.

Once smoke or glassbreak detectors trip, they must be reset before they can detect any additional alarm conditions. When Sensor Reset is selected, power to the detectors is temporarily removed by the system allowing them to reset.

Make sure all smoke is cleared from around the area of the smoke detectors before performing a Sensor Reset to prevent the alarm from occurring again.

### Resetting the Sensors

1. Access the User Menu.
2. When **SENSOR RESET?** displays, press any Select key. The keypad displays **SENSORS OFF** for five seconds followed by **SENSORS ON**.
3. The keypad returns to the status display.

### Sensor (Fire) Reset Shortcut Key

**All Systems** — Press 2 for 2 seconds, then enter your user code if required, to reset the system.

## Outputs On Off

**User Code Level:** Master, Standard, or Limited.

**Function:** Allows you to turn the system outputs on and off.

This function is used to individually turn your system relay outputs on and off. Your system may use these outputs to control interior and exterior lighting, or heating, air conditioning, or other appliances.

The system output names and numbers are located in the System Setup section at the back of this guide.

### Turning the Outputs On and Off

1. Access the User Menu.
2. Press the **COMMAND** key until **OUTPUTS ON/OFF?** displays.
3. Press any Select key.
4. The keypad displays **OUTPUT: - ON OFF**.
5. Enter the output number you want to turn on or off. The output number appears in the display.
6. With the output number displayed, Select **ON** or **OFF**. The output is then turned on or off, depending on your selection, and remains in that state until you change it.
7. The system automatically removes the output number and a new output number can be entered. Refer back to step 5.

To exit the Output menu option, press the Back Arrow key until you return to the keypad Status List.

## Favorite

**User Code Level:** Master or Standard.

**Function:** Allows you to activate a Favorite.

1. When FAVORITES? displays, press any Select key. The keypad displays FAVORITE: -.
2. Enter a Favorite number from 1-20. Pressing COMMAND activates the Favorite.

## Bypass Zones

**User Code Level:** Master or Standard.

**Function:** Allows you to bypass a zone prior to arming the system.

Bypassing is usually done when a zone cannot be restored to normal and you want to arm the system. Once bypassed, the system does not respond to any activity on the zone.

A zone can be bypassed only while it is disarmed. Since Fire, Panic, Emergency, and Supervisory zones are always armed, they can never be bypassed.

The Bypass Zones function can also be used to restore a bypassed zone back into the system. This can only be done while the zone is disarmed. Disarming always resets a bypassed zone.

Your system may be pre-programmed at installation to send a bypass report to your central station when Bypass Zones is selected.

### Using the Bypass Zones Function

1. Access the User Menu.
2. Press the COMMAND key until BYPASS ZONES? displays.
3. Press any Select key. The keypad displays ZONE - RST BYPS.
4. To reset a zone, enter the zone number and Select RST.
5. To Bypass a zone, enter the zone number and Select BYPS.

## Zone Monitor

**User Code Level:** Master, Standard, or Limited.

**Function:** Allows the system to monitor selected disarmed zones (doors, windows, or motion detectors). When a monitored zone trips, the keypad sounds a tone and displays the zone name. This is an ideal feature for monitoring door zones to tell when someone comes in or goes out and for system testing.

You can place any combination of disarmed zones in Zone Monitor but only the most recently tripped zone displays. The displayed zone name clears automatically after a short time or when the zone is armed. Zone Monitor does not function while the system is armed but a zone placed into the Zone Monitor is still monitored when the system is disarmed.

**Using Zone Monitor as part of your weekly system test:** After using the System Test function, place all zones in Zone Monitor. Starting at the front door, walk around and open and then close each door and window. You should hear the keypad beep each time. The keypad also displays the name of each zone as its device is opened.

Once all protected doors and windows are tested, walk in front of each motion detector and trip any other protection devices on the system. The keypad should beep to confirm their operation. If at any time during your weekly testing a device does not cause the keypad to beep, call the service department for assistance.

### Monitor (Chime) Shortcut Key

**All Systems** — Press 5 for 2 seconds when the system is disarmed. This initiates the Zone Monitor operation for all Exit zones in an Area system or all zones assigned to the perimeter in a Home/Sleep/Away or All/Perimeter system. The keypad displays MONITOR ON and chimes or displays MONITOR OFF and no tone is sounded.

## Using the Zone Monitor Function

1. Access the User Menu.
2. Press the COMMAND key until **ZONE MONITOR?** displays.
3. Press any Select key.  
The keypad displays **PERIM ALL NBR**.
4. Select **PERIM** to place all disarmed perimeter zones into Zone Monitor.
  - 4a. The keypad displays **PERIM? ADD RMV**.
  - 4b. Select **ADD** to add all perimeter zones to Zone Monitor.
  - 4c. Select **RMV** to remove all perimeter zones.
5. Select **ALL** to place all disarmed zones into Zone Monitor.
  - 5a. The keypad displays **ALL? ADD RMV**.
  - 5b. Select **ADD** to add all disarmed zones to Zone Monitor.
  - 5c. Select **RMV** to remove all disarmed zones.
6. Select **NBR** to enter a specific zone number for zone monitor.
7. If **NBR** is selected, the keypad displays **ZONE : - ADD RMV**.
  - 7a. Enter any zone number and select **ADD** to add this zone.
  - 7b. Enter any zone number and select **RMV** to remove the zone.
8. The zone number automatically disappears and a new zone number can then be entered. See step 7.

## System Test

**User Code Level:** Master, Standard, or Limited.

**Function:** System Test is used to test the battery, alarm bell or siren, and central station communication. The System Test function begins automatically as soon as you select it.

### Using the System Test Function

1. Access the User Menu.
2. Press the COMMAND key until **SYSTEM TEST?** displays.
3. Press any Select key. The system test begins automatically and the keypad displays:
  - 1) **BELL SOUNDING** during a two second bell test, then:
  - 2) **KEYPAD SOUNDING** during a two second keypad test, then:
  - 3) **BATTERY - OKAY** or **BATTERY - TRBL** to indicate the battery condition, then:
  - 4) **TRANSMIT TEST \*** and **ATTEMPT NO : 1** during the transmit test, then:
  - 5) **TRANSMIT OKAY** or **TRANSMIT FAILED** to show the transmit test results, then:
  - 6) **TEST END** to indicate the System Test is complete.
  - 7) Press the Back Arrow key to end the system test.

\* The transmit test does not occur on local systems.

**Testing your system burglary protection:** The System Test function should be part of your weekly testing and should be followed by placing the interior and perimeter burglary devices in Zone Monitor mode. This allows you to open and then close each protected door and window while listening for the keypad to beep confirming its operation. See Zone Monitor.

## User Codes

**User Code Level:** Master only.

**Function:** Allows you to add or delete a user from the system or change their user code or authority level.

**User code characteristics:** There are three characteristics associated with each user code that define its capabilities within the system.

Characteristic	Example
User Number	22
User Code	3848
Authority Level	Master

**User Number** - The XT30 panel supports 30 users while the XT50 panel supports 99 users. Each user is numbered from 1 to 30 or 1 to 99. This number identifies them to the system and can be transmitted to the central station (if your system is monitored) when they arm or disarm the system.

**User Code** - Users also have a 4-digit user code they enter into the keypad when arming or disarming. This user code is kept secret from other users and is not transmitted to the central station when they arm or disarm.

**Note:** A User Code cannot begin with zero and cannot be left blank. Users enter only their own user code when operating the system.

**User Names** - Each code may also be programmed with the user name. You may enter up to 16 characters for the name. As needed, refer to Appendix C for Entering User Names information.

**Authority Level** - The user is also assigned a level of authority (Master, Standard, Limited, or Scheduled) by the person administering the system to determine the functions the user can access. The XT30 allows Master and Standard users while the XT50 allows all levels of authority.

The Scheduled authority level only functions during a valid schedule, except for arming which can be done at any time.

Disarming is allowed outside of a schedule, but an UNAUTHORIZED ENTRY message is sent to the central station. All other authority levels function regardless of schedules.

The table below lists system functions users are allowed to access based on the authority level assigned to their codes at the time they are added to the system.

User Menu Option	Scheduled (XT50 Only)	Limited (XT50 Only)	Standard (XT30/XT50)	Master (XT30/XT50)
Door Access	Y	Y	Y	Y
Arm and Disarm	Y	Y	Y	Y
Alarm Silence	Y	Y	Y	Y
User Checkin	Y	Y	Y	Y
Zone Activity Check	Y	Y	Y	Y
Sensor Reset	Y	Y	Y	Y
Outputs On/Off		Y	Y	Y
Favorites		Y	Y	Y
Bypass Zones			Y	Y
Zone Monitor	Y	Y	Y	Y
System Test		Y	Y	Y
User Codes				Y
Schedules				Y
Extend			Y	Y
Set Time				Y
Display Events	Y	Y	Y	Y
Service Request?				Y

### Adding User codes

**User Code Level:** Master only.

1. Access the User Menu.
2. Press the COMMAND key until **USER CODES?** displays.
3. Press any Select key.

The keypad displays **ADD DEL CHG SEND**.

4. Select **ADD** to add a new user code.
5. At the **USER NUMBER:** — prompt, enter a user number and press **COMMAND**.
6. The display changes to **CODE NO:.** Enter the four-digit user code and press **COMMAND**.  
This is the number the user enters each time they arm, disarm, or make changes to the system.  
If the code you entered is already in use, or is a code used internally by the system, the keypad displays **ALREADY IN USE**. You must enter a different 4-digit user code.
7. A 16-character name may be entered to identify the user. Press any top row key to clear the current text “user name”. You may then enter the new name. After entering the name press **COMMAND**. See Entering Names in Appendix C.

#### FOR XT30 Panels:

8. The display changes to **MASTER? NO YES**. Select **YES** to make this a Master user level with the authority to access all User Menu functions.  
Select **NO** to make this a Standard user level. Default is set to **NO**. Proceed to step 10a.

#### FOR XT50 Panels:

8. The display changes to **LEVEL: STANDARD**
9. Press any Select key. The keypad displays **SCH LTD STD MSTR**.
10. Select the authority level to assign to the user code. The following user code options can then be selected:
  - 10a. **TEMP CODE NO YES**.  
Select **NO** to make this a permanent user code.  
Select **YES** to make this a temporary code. The keypad displays **TEMP DAYS: - .** Enter the number of days

(1 to 250) that the temporary use code can operate. Default is seven days. Temporary users are deleted from the system at 12:00 AM on the last day. You can delete a Temporary user code at any time before the programmed period ends.

#### 10b. **AREAS:** (Displays in Area systems only).

Enter the area numbers where this user is to have access. For example: if you want this user to only have access to areas 1 and 2, enter the numbers 1 and 2.  
Once the correct area numbers display, press **COMMAND**.

#### 10c. **ARM ONLY NO YES**.

Select **NO** to allow this user to arm and disarm the system and access all Standard level functions in the User Menu.

Select **YES** to restrict this user to arming only.

The Arm Only user code can bypass zones not in a normal condition at the time of arming.

11. After you complete your selections, the keypad displays **USER # ADDED**.
12. Press the Back Arrow key once to add another user or twice to exit the User Menu.

### Changing Own User Code

1. Access the User Menu.
2. Press the **COMMAND** key until **USER CODES?** displays. Press any Select key.
3. The display changes to **USER CODE?**  
**CODE NO: \*\*\*\*\***.  
Press any select key.
4. The user code is erased and display changes to **CODE NO: -**  
Type your new user code. Press **Command**.
5. Display will show **USER XXXX CHNGD** to confirm the change.

## Changing User codes

**User Code Level:** Master only.

1. Access the User Menu.
2. Press the COMMAND key until **USER CODES?** displays.
3. Press any Select key.  
The keypad displays **ADD DEL CHG SEND**.
4. Select **CHG** to change a user code.
5. At the **USER NUMBER:** — prompt, enter the user number to change and press COMMAND.
6. The display changes to **CODE NO: \* \* \* \***. Enter the new user code.  
If the code you entered is already in use, or is a code used internally by the system, the keypad displays **ALREADY IN USE**. You must enter a different 4-digit user code.
7. The display then shows the current user name. Press any top row key to clear. See Entering Names in Appendix C to enter a new name.
8. If you are changing a code other than your own, the keypad next displays **LEVEL?**.
9. Press any Select key. The keypad displays **SCH LTD STD MSTR**.  
Refer to item number 10 in the Adding User Codes section on the previous page.

**Note:** Changing a user code does not change the user number. User number 2 may have their user code changed from 1234 to 5678 but they are still user number 2.

## Deleting User codes

**User Code Level:** Master only.

1. Access the User Menu.
2. Press the COMMAND key until **USER CODES?** displays.
3. Press any Select key.  
The keypad displays **ADD DEL CHG SEND**.
4. Select **DEL** to delete a user code from the system.
5. At the **USER NUMBER:** — prompt, enter the user number you want to delete and press COMMAND. The display changes to **USER # DELETED**.
6. The display then changes back to **USER NUMBER:** — for you to delete another user. Press the Back Arrow key twice to exit the User Menu.

## Sending User codes to Z-Wave locks

**User Code Level:** Master only.

Your system may be pre-programmed at installation to support Z-Wave door locks. This option allows you to send user codes of user numbers 2-20 (Master and Standard) to all compatible Z-Wave locks. Once codes have been received by the lock, a valid user code entered at the lock (by user number 2-20) will lock the door or unlock and disarm the system according to the user's privileges.

1. Access the User Menu.
2. Press the COMMAND key until **USER CODES?** displays.
3. Press any Select key. The keypad displays **ADD DEL CHG SEND**.
4. Select **SEND** to send user codes of user numbers 2-20 (Master and Standard) to all compatible Z-Wave locks on your system.

**Note:** The process of sending the user codes to the locks may take several minutes.

5. If all locks receive the user codes, the display will return to the Status List.
6. If a lock does not receive the user codes, the keypad displays **CODES NOT SENT TO ALL LOCKS**.



## Schedules

**User Code Level:** Master only.

**Function:** The Schedules function allows you to program the times at which you normally turn your burglary protection on and off each day of the week. This information can then be used by the system to automatically arm or disarm the burglary protection.

Your system may be pre-programmed at installation to allow automatic arming and disarming. When programmed, you can enter a schedule for the arming and disarming times.

You can also use the Closing Check/Extend feature with Schedules to ensure your system is armed by an authorized user at a specific time. This option sounds the keypad buzzer and displays **CLOSING TIME!** when a schedule expires. Users still on the premises are required to arm the system or extend the schedule. If the system is not armed, or the schedule not extended, a report can be sent to the central station and/or an email address or cell phone.

When a schedule expires and **CLOSING TIME!** displays, the keypad next displays **ENTER CODE: -**. To silence the keypad buzzer and extend the schedule for one hour, a user must either enter a valid user code or present a card to the card reader.

Also, when a closing schedule expires, your system may turn on the Late to Close Output. This output turns off anytime your system is armed, or a schedule is extended or changed. See System Setup for Output information.

Your system provides you with three different types of schedules:

**Permanent** schedules are used for automatic arming and disarming and always occur at the same time until you change or delete them.

**Extend** schedules allow an authorized user to extend the present day's permanent scheduled closing time.

### XT50 Series Panels Only:

**Output** schedules are used for automatically turning your system outputs ON and OFF and always occur at the same time until you change or delete them. See System Setup for Output information.

**Favorite** schedules are used for automatically activating the devices in a Favorite and always occur at the same time until you change or delete them. See System Setup for Favorite information.

## Permanent Schedules

**User Code Level:** Master only.

1. Access the User Menu.
2. Press the **COMMAND** key until **SCHEDULES?** displays. Press any Select key. The keypad displays **PRM EXT OUT FAV**. Select **PRM**.
3. The keypad next displays the day of the week you want the schedule to start as **SUN MON TUE WED**. Press the **COMMAND** key to show the remaining days of the week and then Select the start day.
4. The keypad displays **OPENING TIME?**. Press **COMMAND**. The keypad now displays **MON - : AM PM**. Enter the time you want the burglary protection to be turned *off*. Use a 12 hour clock only (12:00 to 11:59). Select **AM** or **PM**.
5. The keypad then displays **CLOSING TIME?**. Press the **COMMAND** key. The keypad then displays **MON - : AM PM**. If you want the schedule to be for consecutive days, Select **MON** to increment the days of the week. When the correct day is shown, enter the time you want the burglary protection to turn *on*.
6. To clear a schedule, press **DELETE** and then **AM** when the opening time is requested. Press the Back Arrow key to exit the User Menu.

## Extending Schedules

User Code Level: Master only

**Function:** This option allows users to extend today's programmed closing time schedule.

### Extending a Closing Schedule

1. Access the User Menu.
2. Press the COMMAND key until **SCHEDULES?** displays. Press any Select key.
3. The keypad displays **PRM EXT OUT FAV**. Select **EXT**.  
The keypad displays - : **AM PM**. Enter in the new time for the closing schedule to expire.

## Output Schedules

User Code Level: Master only.

### Setting Output (OUT) schedules

The Schedules function allows you to set up a schedule for each of the four outputs connected to your system to turn ON and OFF automatically.

1. Access the User Menu.
2. Press COMMAND until **SCHEDULES?** displays. Press any Select key.
3. The keypad displays **PRM EXT OUT FAV**. Select **OUT**.
4. At the **OUTPUT NO:** - display, enter the output number you want to program. Press the COMMAND key.
5. The keypad displays **SUN MON TUE WED**. Press the COMMAND key to display **THU FRI SAT**.
6. Select the day you want to program.

**Note:** After selecting the day of the week for the schedule to occur, the keypad displays any currently programmed ON OFF times previously set for that day. This feature allows you to review programmed schedules at any time.

7. If **ON OFF** times display, the keypad then displays **DELETE KEEP**. Select **DELETE** to enter new times.
8. The keypad then displays **ON TIME?**. This is followed by the display - : **AM PM**.

Enter a new output ON time and select **AM** or **PM**.

The display changes to **OFF TIME?**. This is followed by the display - : **AM PM**.

Enter a new OFF time for the output.

Enter all schedule times using a 12 hour clock. For example, to enter 6 AM you would enter a 0 + 6 + 0 + 0 and Select **AM**. For 11 PM you would enter a 1 + 1 + 0 + 0 and Select **PM**.

9. The keypad returns to the day of the week display allowing you to enter another Output schedule. To exit the user menu or to go back to the **SCHEDULES?** display, press the Back Arrow key.
10. To **clear** a schedule press **DELETE** and then **AM** when the opening time is requested.

## Favorite Schedules

**User Code Level:** Master only.

### Setting Favorite (FAV) schedules

The Schedules function allows you to set up a schedule for the Favorites programmed in your system. The Favorite will activate at the scheduled time.

1. Access the User Menu.
2. Press **COMMAND** until **SCHEDULES?** displays. Press any Select key.
3. The keypad displays **PRM EXT OUT FAV**. Select **FAV**.
4. At the **FAVORITE: -** display, enter the Favorite number (1-20) you want to schedule. Press the **COMMAND** key.
5. The keypad displays **SUN MON TUE WED**. Press the **COMMAND** key to display **THU FRI SAT**.
6. Select the day you want to program.
- 7a. If a time has not been set for the day selected, the keypad then displays **ACTIVATE TIME**. This is followed by the display **MON - : AM PM**.  
Enter the activate time and select **AM** or **PM**.  
Enter all schedule times using a 12 hour clock. For example, to enter 6 AM you would enter a 0 + 6 + 0 + 0 and Select **AM**. For 11 PM you would enter a 1 + 1 + 0 + 0 and Select **PM**.
- 7b. If a time has been set for the day selected, the keypad displays Act Time with the time programmed. Press a select key to display the **DELETE** and **KEEP** options. Select **DELETE** to enter a new time. Select **KEEP** to keep the current time setting.
8. The keypad returns to the day of the week display allowing you to enter another Favorite schedule. To exit the user menu or to go back to the **SCHEDULES?** display, press the Back Arrow key.

## Date and Time

**User Code Level:** Master only.

**Function:** Allows you to change the current date and time displayed on the keypad and used by the system for schedules and Display Events.

### Setting the Date and Time

1. Access the User Menu.
2. Press **COMMAND** until **TIME?** displays. Press any Select key.
3. The keypad displays the current day and time. Press the **COMMAND** key to display the current date. Press the **COMMAND** key again to make any changes.
4. The keypad displays **TIME DAY DATE**. Select **TIME** to change the time. The keypad displays - : **AM PM**. Enter the current time and select **AM** or **PM**.
5. The display changes back to **TIME DAY DATE**.
6. Select **DAY** to change the day of the week. The keypad displays **SUN MON TUE WED**. If the current day does not display, press the **COMMAND** key. Select the correct day.
7. Select **DATE** to change the date. The keypad displays:
  - MONTH:** - Enter up to two digits for the month. Press **COMMAND**.
  - DAY:** - Enter up to two digits for the day. Press **COMMAND**.
  - YEAR:** - Enter up to two digits for the year. Press **COMMAND**.

The display returns to **TIME DAY DATE**. Press the Back Arrow key to exit the User Menu.

## Display Events

**User Code Level:** Master, Standard, Limited, or Scheduled.

**Function:** Allows you to view up to 100 (XT30) or 200 (XT50) past events that occurred on your system from any keypad. Any event older than 45 days automatically clears from the system memory. Once the full 100 or 200 events are reached, any new event received clears the oldest event from the list.

Refer to Appendix A for detailed Display Events information.

### Request Service?

**User Code Level:** Master only.

**Function:** Allows you to send a Request for Service message to the central station when there is a problem on your system.

After the Display Events option in the keypad User Menu, the **REQUEST SERVICE?** option displays if a master code was used to enter the menu. This feature does not display if it is not enabled on your system.

If your system is monitored by a central station and you need to send a Request for Service report to the central station, press any Select key while **REQUEST SERVICE?** displays. After the Request for Service report is sent, the keypad displays **REQUEST MADE** for four seconds.

If there is a problem with the telephone line connected to the system, you must contact our service department directly for assistance.

# System Setup

## System Setup Record

This System Setup section is provided to allow you to track the current status of programmable options on your XT Series™ system. If you make changes to the system, you should update the information contained on these pages.

Your system is monitored by a central station.

Yes  No

C/S Name: \_\_\_\_\_

Address: \_\_\_\_\_

City/State: \_\_\_\_\_

Emergency Phone: \_\_\_\_\_

Service Phone: \_\_\_\_\_

Service Manager: \_\_\_\_\_

Your system sends Opening and Closing reports.

Yes  No

Your system sends Zone Bypass reports.

Yes  No

Your system sends Ambush reports.

Yes  No

## Protection Areas

Your system may be divided into six separate areas, each area can have a name or description that displays at the keypad. This can help you easily track events when they occur elsewhere in your system.

Area #	What it Controls
1	_____
2	_____
3	_____
4	_____
5	_____
6	_____

## Output Record

Your system has outputs that can be used for various functions. The list below identifies the output numbers and device names.

Output #	What it Controls
_____	_____
_____	_____
_____	_____
_____	_____
_____	_____
_____	_____
_____	_____

Use the Output number in the User Menu when using the Outputs On Off option to manually operate the relays.



## Key Fob Button Programming

Enter the user name assigned to each key fob and the button action programmed for each button in the table below. Refer to the Introduction and Appendix B for more information.

Key Fob User Name	Button	Programmed Action
	TOP	
	BTM	
	LFT	
	RGT	
	TOP	
	BTM	
	LFT	
	RGT	
	TOP	
	BTM	
	LFT	
	RGT	
	TOP	
	BTM	
	LFT	
	RGT	
	TOP	
	BTM	
	LFT	
	RGT	
	TOP	
	BTM	
	LFT	
	RGT	

## User Codes

The XT30 system provides 32 user codes you can program for individual users and the XT50 system provides 99. As you add new users or change current user codes, you can keep track of their name, user number, and other information here in this section. Use a pencil to allow for changes in the table on the next page.

User #	User Name	Level*	Temp Code	Temp Days	Areas	Arm Only
			Y N		1 2 3 4 5 6	Y N
			Y N		1 2 3 4 5 6	Y N
			Y N		1 2 3 4 5 6	Y N
			Y N		1 2 3 4 5 6	Y N
			Y N		1 2 3 4 5 6	Y N
			Y N		1 2 3 4 5 6	Y N
			Y N		1 2 3 4 5 6	Y N
			Y N		1 2 3 4 5 6	Y N
			Y N		1 2 3 4 5 6	Y N
			Y N		1 2 3 4 5 6	Y N
			Y N		1 2 3 4 5 6	Y N
			Y N		1 2 3 4 5 6	Y N
			Y N		1 2 3 4 5 6	Y N
			Y N		1 2 3 4 5 6	Y N
			Y N		1 2 3 4 5 6	Y N
			Y N		1 2 3 4 5 6	Y N

### HOW TO FILL IN THIS TABLE

**User #** - The User Number of the person authorized to use the system.

**Level\*** - Master, Standard, Limited, or Scheduled authority.

**Temp Code** - Is this code set to expire?

**Temp Days** - The number of days a temporary user has authority to use the system.

**Areas** - What areas does this user have the authority to arm and disarm?

**Arm Only** - Is this user restricted to just arming?

Refer to the User Codes section of this User's Guide for additional information.

- \* Master (MST)
- Standard (STD)
- Limited (LTD)
- Scheduled (SCH)

(Photocopy this page before using.)

Circle Your Selections



# Appendix A

## About the Display Events Section

User Code Level: Master, Standard, Limited, or Scheduled.

While in the Display Events function, use the COMMAND and Back Arrow keys to move forward or backward through the list of events. To view more information about each display, press the Select key as directed in the explanations below.

**Note:** This section shows the User's Guide Display Events items for 32-character keypad displays.

### Using the Display Events Function

1. Access the User Menu.
2. Press the COMMAND key until **DISPLAY EVENTS?** displays. Press any Select key.
3. The keypad displays **FIRST LAST**.

Select **FIRST** to view events starting from the oldest to the newest. If you select **FIRST**, use the COMMAND key to scroll up through the events displays.

Select **LAST** to view events starting from the newest to the oldest. If you select **LAST**, use the Back Arrow key to scroll down through the event displays.

Display Events allows you to view up to 100 (XT30) or 200 (XT50) past events that occurred on your system from any keypad. Any event older than 45 days automatically clears from the system memory. Once the full 100 or 200 events are reached, any new event received clears the oldest event from the list.

## Zone Activity Check Event Display

This displays the date and time the Zone Activity Check was enabled or disabled.

### Description

The Zone Activity Check was disabled at 5:18 PM on October 17.

```
MSG  5:18P  10/17
ACT DISABLED
```

Activity Check Event Types - There are three event types:

**ACT DISABLED**      **ACT ENABLED**      **NO ZONE ACTIVITY**

## Zone Bypass Event Displays

This displays the system zones bypassed.

### Description

The east window zone was bypassed. Press any Select key for the zone number and user number.

```
BYP  5:18P  10/17
EAST WINDOW
```

Bypass Event Types - There are three event types:

**BYP** - Bypass      **RST** - Restore      **FRC** - Force Arm

**Note:** You may sometimes see the user as **SWG**. This is short for Swinger Bypass which is an automatic function that allows the system to bypass a zone.

## Zone Event Displays

This section displays alarms, troubles, and other events that could occur on your protection zones.

ALR	10:23P	10/17
BASEMENT DOOR		

### Description

An alarm occurred at 10:23 PM on October 17. Press any Select key to see the zone number and zone type.

Zone Type - There are seven possible zone types you may see here.

**FIRE** - Fire      **PANC** - Panic      **BURG** - Burglary

**EMRG** - Emergency      **SUPV** - Supervisory

**AUX1** - Auxiliary 1      **AUX2** - Auxiliary 2

Event Types - There are seven event types you may see here:

**ALR** - Alarm      **TBL** - Trouble      **RST** - Restore

**FLT** - Zone Fault      **SVC** - Service Smoke Detector

**LOW** - Low battery      **MIS** - Missing wireless transmitter

**Note:** LOW and MIS are for wireless systems only.

## Arming and Disarming Event Displays

This displays any system areas arming or disarming.

ARM	5:10P	10/17
WAREHOUSE		

### Description

The warehouse area was armed at 5:10 PM. Press any Select key to display the area number and user number.

Arming Event Types - There are two event types you may see here:

**ARM** - User armed the system      **DIS** - User disarmed the system

## User Check-in Event Displays

This shows when a user selected the email Check-in feature from the User Menu. See page 16 for more information.

MSG	3:31P	10/17
CHECKIN	USER:	16

### Description

User 16 selected the Check-in feature at 3:31 PM on Oct. 17.

## User Code Change Event Displays

This displays any user code additions, deletions, or changes.

ADD	11:41A	10/17
US:19	BY	US:12

### Description

At 11:41 AM user 12 added user 19.

User Code Event Types - There are three event types you may see here:

**ADD** - User added      **DEL** - User deleted

**CHG** - User code or authority level was changed.

## Supervisory Event Displays

This displays the automatic test report date and time.

MSG 11:58P 10/17 AUTO RECALL
---------------------------------

### Description

The test report was sent to the central station at the date and time shown.

## System Monitor Event Displays

This displays any problems with the system AC power or battery.

TBL 11:41A 10/17 AC POWER
------------------------------

### Description

An AC failure occurred at 11:41 AM on October 17.

System Monitor Event Types - There are two event types:

TBL - Trouble      RST - Restore

System Monitor Event Names - There are two system monitors:

AC POWER      BATTERY

## Wireless Jamming Event Displays

This displays wireless interference events that have occurred.

### Keypad Display

ALR 11:41A 10/17 WIRELESS
------------------------------

### Description

The DMP wireless receiver detected interference on October 17 at 11:41 AM.

Wireless Jamming Event Types - There are three event types:

TBL - Trouble (an interference event occurred when the panel was disarmed)

ALR - Alarm (an interference event occurred when any area was armed)

RST - Restore

## Wireless Trouble Event Displays

This displays events when the wireless receiver was not communicating with the panel.

### Keypad Display

TBL 11:41A 10/17 WIRELESS
------------------------------

### Description

A DMP wireless receiver trouble occurred on October 17 at 11:41 AM.

Wireless Trouble Event Types - There are two event types:

TBL - Trouble

RST - Restore

# Appendix B

## 1100 Series Wireless Description

If your system uses wireless devices and includes key fob(s), refer to the following information. The wireless section includes a brief discussion of key fob(s) and a drawing identifying the key fob buttons. Refer to the System Setup section of this guide to check the button programming list for key fob(s) connected to your system.

For best operation, allow the LED to turn on and then turn off before pressing another button. The key fob may not complete sending the signal for the button press if another button is pressed too soon.

### LED Status Operation

Depending on the programmed action of a key fob button, the Status LED lights to acknowledge a button press or to indicate the armed state of the system.

- When the button is programmed for Panic, Panic 2, Emergency, Emergency 2, Output, or Sensor Reset, a 1/2 second Green light displays to acknowledge the button press.
- When the button is programmed for Arm, Disarm, Toggle (Arm/Disarm), or Status, the system armed status is received by the key fob and the LED lights once as shown in the table below.

LED Color	Duration	Description
Red	2.0 Seconds	All System On
Green	2.0 Seconds	All System Off
Green/Red	2.0 Seconds	System On (Some Areas Armed)

When a button is pressed that is not programmed, the LED does not operate.

# Appendix C

## User's Guide

This section of the user's guide provides information on using the XT Series™ system door access capability. If your system is not currently using any door access devices, disregard this section. The keypad displays for All/Perimeter or Home/Away operation are dependent on how your keypad was programmed by your alarm dealer.

There are three different operating modes: Door Strike, Arming and Disarming, and Entry Delay. All of the examples below assume that your system requires a user code to arm and disarm the protection.

### DOOR STRIKE

**Area and All/Perimeter Door Strike** – From the Status List, present your card to the reader. When the card is validated by the system, the Door Strike relay activates for 5 seconds during which time you can open the door. Once you open the door, you have 40 seconds to exit and close the door before the Zone 2 Soft-Shunt expires.

**Home/Away systems** only activate the Door Strike relay when arming and disarming.

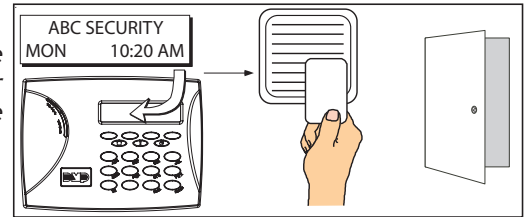

### ARMING AND DISARMING AN AREA SYSTEM

Press **COMMAND**, the keypad displays **ARM DISARM?**. Press the Select key under either option.

The keypad displays **ENTER CODE: -**.

Present your card to the reader. Once the system validates the card, all areas accessible by you arm or disarm automatically and the Door Strike relay activates.

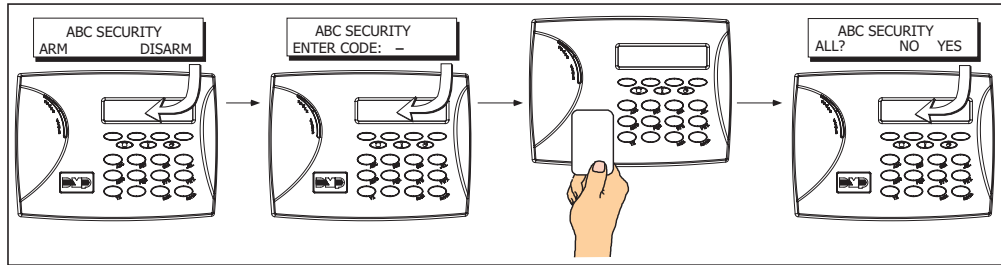

## ARMING AND DISARMING AN ALL/PERIMETER SYSTEM

Press **COMMAND**. The keypad displays **PERIM ALL** (when arming) or **DISARM?**. Press the Select key under the desired option. The keypad displays **ENTER CODE: -**.

Present your card to the reader. Once the system validates the card, if you choose **PERIM**, only the perimeter arms. If you choose **ALL**, both areas arm. If programmed on a 32-character keypad, **ALL** is automatically chosen for you after a short delay. All armed areas disarm automatically.

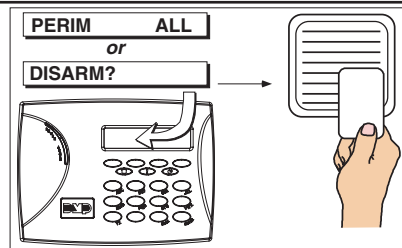

## ARMING AND DISARMING A HOME/AWAY SYSTEM

Present your card to the reader. If the system is armed, once the system validates the card, all areas are disarmed and the keypad displays **ALL SYSTEM OFF**.

If the system is disarmed when you present your card, once the system validates the card, **HOME SLEEP AWAY** displays. You can manually press the Select key under the desired option or after short time all areas automatically arm in the **AWAY** mode.

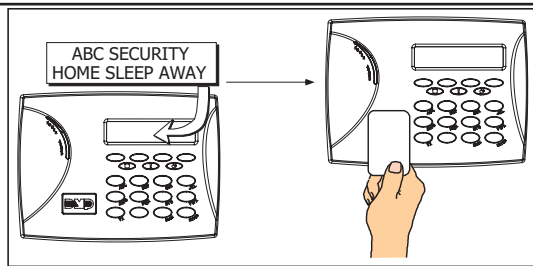

## ENTRY DELAY

**All Systems** - Once the protected door is opened and the entry delay starts, the keypad displays **ENTER CODE: -**. Present your card to the reader and, once validated, the system disarms all areas and activates the Door Strike relay. The top line of 32-character keypads displays the zone name. Area systems provide a delay to allow selected areas only to be disarmed. See Arming and Disarming above and on the previous page.

### Using the access reader for user menu access

You can also use a card reader to access the User Menu when **MENU? NO YES** displays.

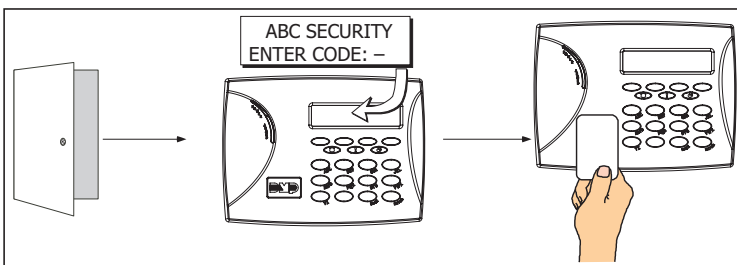

## Entering User Names

Refer to the following when entering names information into the keypad.

1

Para ingresar un nombre desde el teclado, deberá utilizar las tres filas del teclado numérico.



2

Debajo de cada numero hay impresas tres letras. Para ingresar un nombre, pulse la tecla numérica que está por encima de la letra que quiere ingresar.

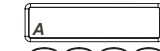
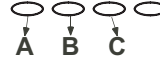
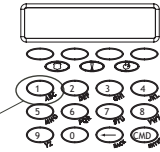

Una vez que haya borrado el nombre por defecto, la pantalla mostrará un guión sobre el extremo izquierdo.

3

Cuando se muestre el numero que ingreso, pulse la tecla/sector Seleccionar que se corresponde con la posición de la letra que quiere ingresar

4

Una vez que la pantalla muestre la letra que quiere ingresar, pulse la tecla numérica ubicada por encima de la siguiente letra que quiere ingresar. Usted puede ingresar hasta 16 caracteres para cada nombre.

Las teclas nueve(9) y cero.(0) . . .



Si usted pulsa la tecla 9, podrá ingresar las letras Y,Z y un espacio para separar palabras. Por ejemplo para separar el nombre y apellido BOB SMITH.



Si usted pulsa la tecla 0, podrá ingresar -(guión), .(punto), \*(asterisco), y #(numeral)

# Appendix D

## Email/Cell Phone Message User's Guide

Your security system's reporting capability can be used to send reports to an email address or cell phone number in much the same way as someone sending you an email would do. You can receive reports of alarms, troubles, or system armings and disarmings and know at a glance your system status.

The following are types of messages that can be sent:

- \* Zone Alarms by Zone Name
- \* Zone Bypass by User
- \* Disarming (Openings) by User
- \* Late to Open
- \* AC Power (and restoral)
- \* Ambush
- \* Alarm Verified by User
- \* In-Activity
- \* Zone Troubles by Zone Name
- \* Armings (Closings) by User
- \* Late to Close
- \* Early to Close
- \* System Low Battery
- \* Abort & Cancel by User
- \* Check-in by User

For alarm messages, the message provides the system name, zone name, zone number, and message type.

Each alarm message will be detailed in the following way:

- \* Fire = Fire Alarm
- \* Burglary = Burglary Alarm
- \* Panic = Panic Alarm
- \* All other types = Alarm

From: John's Home System (mailto: AlarmAdmin@ABCSecurity.com)  
Sent: Wednesday, June 04, 2008 8:33 AM  
To: JohnSmith@myhome.com  
Subject: Fire Alarm Message

The John's Home System has a **\*\*Fire Alarm\*\*** on the Hall Smoke Alarm.

From: John's Home System (mailto: AlarmAdmin@ABCSecurity.com)  
Sent: Wednesday, June 04, 2008 9:01 AM  
To: JohnSmith@myhome.com  
Subject: Check-in Message

Cindy H has checked in at the John's Home System.

From: John's Home System (mailto: AlarmAdmin@ABCSecurity.com)  
Sent: Wednesday, June 04, 2008 10:05 AM  
To: JohnSmith@myhome.com  
Subject: System Message

John's Home System has an AC Power Failure.

### Examples of email messages



## MyAccess™ Text Messaging Commands

Your system may be programmed to allow simple text messages to be sent to the security system and perform basic user operations. By texting a message from your cell phone or PDA, the following actions can be performed: Arm/Disarm, Cancel Alarm, turn Outputs On/Off, check Armed Status, Turn on and off lights, Lock and unlock doors, and Set the thermostat. .

The user that is texting commands to the system must have the authority to perform the commands as if it occurred at the keypad. The cell phone number and user numbers are setup during programming.

After programming is completed, you will receive a welcome message text from the panel. Write down the phone number that the message comes from. This will be the number you use to text user operations to the system.

**Note:** When texting commands listed below, the commands can be either upper or lowercase.

A list of text commands can be obtained by texting “help” to the system phone number. Store this number in your cell phone and write the number on the Quick Reference Wallet Card located at the back of this manual.

### Arming All Areas with Text Message Commands

1. Text message your system panel with the following command:
  - ARM, AWAY, or ALL: To arm all areas, depending on your system

### Arming Partial Areas with Text Commands

1. Text message your system panel with the following command:
  - SLEEP: To arm the perimeter and interior of a Home/Sleep/Away system.
  - HOME: To arm just the perimeter of a Home/Away/Sleep system.
  - PERIM: To arm the perimeter of an All/Perimeter system.
  - ARM “Area Number” or ARM “Area Name”: To arm specific areas of an Area system.

The NAME should identify the area name. The NUMBER should identify the area number. Names and numbers can be mixed, and a comma should separate the areas. If ARM is sent without any other words, all areas are armed.

If the system is already armed, you can arm it again only if you are arming more areas than were originally armed.

### Disarming All Areas with Text Message Commands

1. Text message your system panel with the following command:
  - DISARM: To disarm all areas.

### Disarming Partial Areas with Text Message Commands

1. Text message your area system panel with the following command:
  - DISARM “Area Number” or DISARM “Area Name”: To disarm specific areas of an Area system.

The NAME should identify the area name. The NUMBER should identify the area number. Names and numbers can be mixed, and a comma should separate the areas. If DISARM is sent without any other words, all areas will be disarmed.

If the system is already disarmed, you will receive a message saying that the system is already disarmed.

## **Cancelling an Alarm with Text Messaging**

While the alarm bell or siren sounds, you may choose to cancel the alarm via text messaging.

1. If a valid alarm has not occurred, text **CANCEL** to disarm the system and cancel the alarm.

## **Turning Outputs On/Off/Momentary with Text Messaging**

Allows you to set the state of any output to on, off, or momentary.

1. To set the Output to ON Steady, text ON followed by the Output name or number. For example, to turn Output 3 on, you would text: ON Lights or ON 3.
2. To turn the Output to OFF, text OFF followed by the Output name or number. For example, to turn Output 3 off, you would text: OFF 3 or OFF LIGHTS.
3. To turn the Output to ON MOMENTARY (the output turns on for one second, and then off), text MOMENTARY followed by the Output name or number. For example, to turn Output 3 to momentary, you would text: MOMENTARY 3.

## **Turning Lights On/Off with Text Messaging**

Allows you to turn Z-Wave compatible lights on or off.

1. To turn a specific light on, text TURN ON followed by the light name. For example, to turn Bedroom Light on, you would text: TURN ON BEDROOM LIGHT.
2. To turn a specific dimmer light on to a certain level, text TURN ON followed by the light name and the dimmer level (1-10). For example, to turn Front Dimmer Light on to level 8, you would text: TURN ON FRONT DIMMER 8.
3. To turn a specific light off, text TURN OFF followed by the light name. For example, to turn Bedroom Light off, you would text: TURN OFF BEDROOM LIGHT.

## **Locking/Unlocking Door Locks with Text Messaging**

Allows you to lock/unlock Z-Wave compatible door locks.

1. To lock a specific lock, text LOCK followed by the lock name. For example, to lock the Front Door, you would text: LOCK FRONT DOOR.
2. To unlock a specific lock, text UNLOCK followed by the lock name. For example, to unlock the Front Door, you would text: UNLOCK FRONT DOOR.

## **Setting Thermostat with Text Messaging**

Allows you to set Z-Wave compatible thermostats with specific temperatures.

1. To set the thermostat to Cool or Heat with a specific temperature, text SET followed by the thermostat name followed by HEAT or COOL followed by the temperature. For example, to turn Main Thermostat on to COOL and 65°, you would text: SET MAIN THERMOSTAT COOL 65.
2. To set the thermostat to Auto with specific heat and cool temperatures, text SET followed by the thermostat name followed by AUTO followed by the high temperature and the cool temperature. For example, to turn Main Thermostat on to AUTO with temperatures of 80° and 60°, you would text: SET MAIN THERMOSTAT AUTO 80 60.
3. To set the thermostat fan to Auto or On, text SET followed by the thermostat name followed by FAN followed by ON or AUTO. For example, to turn the Main Thermostat fan on, you would text: SET MAIN THERMOSTAT FAN ON.

## **Activating Favorites with Text Messaging**

Allows you to activate a Favorite of Z-Wave compatible devices.

1. To activate a Favorite, text ACTIVATE followed by the Favorite name. For example, to activate the Favorite named House Lights, you would text: ACTIVATE HOUSE LIGHTS.

### **Check Armed Status Text Command**

Allows you to check the system armed status. If armed, the system will send a message stating the type of system you have followed by ON, such as ALL SYSTEM ON or HOME SYSTEM ON. If disarmed and no open zones, the system will send SYSTEM READY. If disarmed with open zones, it will send SYSTEM NOT READY followed by any open zones. A message of AC POWER TROUBLE will indicate when a power failure occurs. If in alarm or trouble, the system will send ALARM ON or TROUBLE ON followed by up to 3 zone names that are in alarm or trouble.

1. To receive the Armed Status, text: STATUS.

### **Check Status of Lights, Locks, and Thermostats Text Command**

Allows you to check the status of Z-Wave compatible lights, locks, and thermostats. The status shows which devices are currently on and any devices that are not responding.

1. To receive the Status of Z-Wave compatible lights, text: STATUS LIGHTS.
2. To receive the Status of Z-Wave compatible locks, text: STATUS LOCKS.
3. To receive the Status of Z-Wave compatible thermostats, text: STATUS THERMOSTATS.

### **Subscribe to Text Messages**

Allows you to set which text messages you receive from the panel. When your system is programmed to allow text messages, you will not be subscribed. To change your subscription status, follow the instructions below for desired messages.

1. Text the words SUBSCRIBE STATUS ALL to receive a text message for all arming and disarming occurrences in addition to any alarm.
2. Text the words SUBSCRIBE STATUS NONE to not receive a text message for arming and disarming occurrences, but still receive a text message for any alarm.
3. Text the words SUBSCRIBE STATUS OTHERS to receive a text message for all arming and disarming occurrences originating from other users, in addition to any alarm. This option will send a text message for all arming and disarming occurrences except for the ones you initiate at a keypad.
4. Text the word SUBSCRIBE to show the current subscription status and the available subscription options.

## PhoneAccess™ User's Guide

For your reference a PhoneAccess™ pocket guide is provided on the last page of this User's Guide.

This exciting feature allows you to call your XT30/XT50 system from any outside touch-tone phone to arm and disarm protection areas or turn panel relay outputs on or off. Faulted zones force arm when the area arms.

### How it works

**Note:** If your telephone system shares the phone line with a fax machine or answering machine, call and let the phone ring once, then hang up, and redial. The panel seizes the phone line so you can check system status and arm or disarm the system.

1. From a touch tone phone, call the system phone number. The XT30/XT50 answers and sounds a short ready tone.
2. You now have eight seconds to enter a valid *Master* user code. If the panel accepts the user code, you hear one or more beeps indicating the system current armed status.

The following table identifies the beeps and what they represent.

If	You will hear
All areas are armed	3 short beeps
Area 1 (Perimeter) is armed	1 short beep
Any area is armed	2 short beeps
All areas are disarmed	1 long beep

**Note:** You can also find out the system armed status by pressing the \* key at any time.

3. If the user code is not accepted by the panel, you hear four short beeps. Check the user code and try again. After three unsuccessful attempts to enter the code, the panel locks out PhoneAccess™ until a valid user code is entered at a keypad.
4. Once the user code is accepted by the panel and the armed status is given, you can enter arming and disarming commands.

Press	For this action	You will hear
# then 1	Arm all	3 short beeps
# then 2	Arm Perimeter	1 short beep
# then 3	Arm Perimeter/Interior	2 short beeps
# then 0	Disarm all areas	1 long beep
#, 5, 4, 0, n*	Toggles the output	1 short beep = on 1 long beep = off 4 short beeps = restricted

\* Use outputs 1, 2, 3 or 4 in place of n. Enter output descriptions below.

**Note:** Zones in a faulted condition are force armed when the area arms.

1. \_\_\_\_\_
2. \_\_\_\_\_
3. \_\_\_\_\_
4. \_\_\_\_\_

## Common Keypad Displays

Listed below are several keypad messages you may see on the display. Follow the instructions in the Possible Solutions column to correct the problem. In many cases, you need to call a service person to correct the problem. Displays not discussed here indicate your service representative should be called.

Message	Tone at Keypad	Meaning	Possible Solutions
INVALID CODE	No	The user code you entered is not recognized by the system.	Check the user code and try again.
CLOSING TIME	Yes	The schedule has expired but the system has not been armed.	Users still on the premises are reminded to arm the system or extend the schedule to a later time.
AC TROUBLE	Yes	The system is not getting proper AC power.	Contact your service person if other electrical devices in your home are working.
BATTERY TROUBLE	Yes	The battery is either low or missing.	Contact your service person.
SYSTEM TROUBLE or SERVICE REQUIRED	Yes	There is a problem with one or more components in the system.	Contact your service person.
SYSTEM BUSY	No	The system is performing another task with a higher priority.	Wait a few moments for the system to complete the task. Contact your service person if the problem remains.
4-WIRE BUS TROUBLE	No	There is not a supervised device on the bus.	Contact your service person.
		The voltage is low or there is an open yellow wire.	
		Two devices share the same address.	
TRANSMIT FAIL	Yes	The panel has attempted to communicate with the central station ten times and has not succeeded.	Make sure your telephone line is working properly. Contact your service person if the problem remains.
NON-POLLED ADDRESS	No	Keypad is set to an invalid address.	Contact your service person.
WIRELESS TROUBLE	Yes	The panel is unable to communicate with the wireless receiver.	Verify the receiver is properly connected to the panel. Verify the correct House Code is programmed in System Options.
		The wireless receiver is missing.	
LOBAT	Yes	The Z-Wave Lock device has a low battery	Contact your service person.

## Symbols

- 2-Button Panic Keys 5
- 7/0 Panic Function 5
- 24-Hour Zone 10

## A

- Alarm Cancel 17, 19
- ALARM display 8
- Alarm Silence b, 7, 17, 19
- Alarm Verify 17, 19
- All/Perimeter System 15
  - Alarm Silence b
  - Arming 15
  - Disarming 17, 19
  - Shortcut Keys 15, 20
- Aqualite™ Keypad 3
  - Panic Keys 5
- Area System
  - Alarm Silence b
  - Arming 13
  - Disarming 14
  - Schedules 29
- Arming 12
  - All/Perimeter 15, 41, 42
  - Area 13
  - Home/Away 17, 42
  - Instant 15
  - Key Fob 13
  - Shortcut Keys 15, 17, 20
- Arming/Disarming Event Display 38

## B

- Back Arrow (<—) Key 6
- Backlighting 6
- Bypassing zones 12, 18, 21, 24

## C

- Cancel Alarm b, 17, 19, 46
- Central Station Monitoring 10
- Changing User codes 28
- Check-in Report to Pager 20, 22
- Clear Touch™ Keypad
  - Panic Icons 5
- COMMAND (CMD) Key 6
- Common Keypad Displays 45

## D

- Data Entry Keys 6
- Date and Time 32
- Disarming 14
  - All/Perimeter 16, 42
  - Area 14
  - During an Alarm 17, 19
  - Home/Away 19, 42
  - Key Fob 13
- Display Events 32, 37
  - Arming and Disarming 38
  - Supervisory 39
  - System Monitor 39
  - User Events 38, 39
  - Wireless Events 39
  - Zone Events 37, 38

## E

- Easy Entry™ User's Guide 41
- Easy Exit™ Shortcut Key 20
- Emergency Evacuation Plans 2
- ENTER CODE display 9
- Entering User Names 43
- Entry Delay 42
- Entry or Exit Zone 10

- Event Displays 37
  - Arming and Disarming 38
  - Supervisory 39
  - System Monitor 39
  - User Check-In 38
  - User Code Change 38
  - Wireless Jamming 39
  - Wireless Trouble 39
  - Zone Activity check 37
  - Zone Bypass 37
  - Zone Events 38
- Exit Error 11
- Extending Schedules 30

## F

- False Alarms 1

## H

- Home/Away System 17
  - Alarm Silence b
  - Arming 17
  - Disarming 18
  - Easy Exit™ Shortcut Key 19
  - Shortcut Keys 17, 20
- How Your System Operates 12

## I

- Instant Arming 16
- Instant Zone 10

## K

- Keypad
  - 2-Button Panic Keys 5
  - Alarm 8
  - Backlighting 6
  - Displays 49
  - Key Definitions 6

- LEDs 4
- Select Keys 4
- Shortcut Keys 19
- SYSTEM TROUBLE 9
- Tones 7
- Types 3
- User Menu 1
- User Options 6
- Volume 6
- Wireless Displays 8
- Key Fob 8, 35, 40
  - Arming 13
  - Button Layout 8
  - Button Programming 35
  - Disarming 13
  - LED Operation 40
  - Status Table 40
  - User Record 34

**L**

- LED Operation 4, 5, 40

**O**

- Outputs On Off 23
- Output Schedules 30

**P**

- Pager Direct™ 44
- Permanent Schedules 29
- PhoneAccess™ 53
- Power LED 4, 5

**R**

- Request Service? 32
- Resetting the Sensors 20, 23

**S**

- Schedules
  - Extending 30
  - Output 30
  - Permanent 29
- Security System Terms 9
- Select Keys 4
- Sensor Reset 23
- Setting the Date and Time 32
- Shortcut Keys 15, 17, 19, 22, 23, 24
  - Arming Function 15, 17, 20
  - Check-in (Latch Key) Report Function 20, 22
  - Easy Exit™ Function 20
  - Monitor (Chime) Function 20, 24
  - Sensor (Fire) Reset Function 20, 23
- Silencing an Alarm b, 7
- Status List 10
- Supervisory Event Display 39
- System Monitor Event Display 39
- System Ready/System Not Ready 15, 17
- System Setup Record 33
- System Test 25

**T**

- Test Your System Weekly 1
- Thinline™ Keypad 4, 5, 6, 7
  - LEDs 3
  - Panic Keys 5
- TROUBLE display 9
- Trouble Tone Response b, 7

**U**

- User Check-In Event Display 38
- User Codes 26
  - Authority Levels 26
  - Change Event Display 38
  - Changing 27, 28

- Deleting 28
- Names 26, 43
- Table 36
- User Menu Options 21, 26

**V**

- Verify Alarm b, 17, 19

**W**

- Wireless 8, 40
- Event Displays 39

**Z**

- Zone 10
- Zone Activity Check 22
- Zone Event Display 38





# Quick Reference Wallet Cards

## PhoneAccess™ Quick Commands

Press	For this action	You will hear
# then 1	Arm all	3 short beeps
# then 2	Arm Perimeter	1 short beep
# then 3	Arm Perimeter/Interior	2 short beeps
# then 0	Disarm all areas	1 long beep
#, 5, 4, 0, n*	Toggles the output	1 short beep = on 1 long beep = off 4 short beeps = restricted

Note: Zones in a faulted condition are force armed when the area arms.

\* Use outputs 1, 2, 3, or 4 in place of n. Enter output descriptions below.

- \_\_\_\_\_ 3. \_\_\_\_\_
- \_\_\_\_\_ 4. \_\_\_\_\_

## MyAccess™ Text Messaging Quick Commands

Panel Phone Number: \_\_\_\_\_

Text	For this action
HELP	List of text commands
ARM, AWAY, ALL	Arm all areas of your system
SLEEP	Arm Perimeter and interior of a Home/Sleep/Away System
HOME	Arm perimeter of a Home/Sleep/Away System
PERIM	Arm perimeter of an All/Perimeter System
ARM NAME, #	Arm specific areas (enter area NAME or #) of an Area System
DISARM	Disarm all areas of your system
DISARM NAME, #	Disarm specific areas (enter area NAME or #) of an Area System
Status	To receive a status update
Cancel	Cancel alarm while the alarm bell or siren sounds
ON (Output name or #)	Turns the Output specified to ON Steady
OFF (Output name or #)	Turns the Output specified to OFF

Cut along dotted lines.

# Quick Reference Wallet Cards

## MyAccess™ Text Messaging Quick Commands

Panel Phone Number: \_\_\_\_\_

Text	For this action
HELP	List of text commands
ARM, AWAY, ALL	Arm all areas of your system
SLEEP	Arm Perimeter and interior of a Home/Sleep/Away System
HOME	Arm perimeter of a Home/Sleep/Away System
PERIM	Arm perimeter of an All/Perimeter System
ARM NAME, #	Arm specific areas (enter area NAME or #) of an Area System
DISARM	Disarm all areas of your system
DISARM NAME, #	Disarm specific areas (enter area NAME or #) of an Area System
STATUS	To receive a status update
CANCEL	Cancel alarm while the alarm bell or siren sounds
ON (Output name or #)	Turns the Output specified to ON Steady
OFF (Output name or #)	Turns the Output specified to OFF

## MyAccess™ Text Messaging Quick Commands

Panel Phone Number: \_\_\_\_\_

- Area Names:
- \_\_\_\_\_ 2. \_\_\_\_\_
  - \_\_\_\_\_ 4. \_\_\_\_\_
  - \_\_\_\_\_ 6. \_\_\_\_\_
- Output Names:
- \_\_\_\_\_ 2. \_\_\_\_\_
  - \_\_\_\_\_ 4. \_\_\_\_\_
  - \_\_\_\_\_ 32. \_\_\_\_\_
  - \_\_\_\_\_ 34. \_\_\_\_\_
  - \_\_\_\_\_ 42. \_\_\_\_\_
  - \_\_\_\_\_ 44. \_\_\_\_\_

Cut along dotted lines.

Text	For this action
OFF (Output name or #)	Turns the Output specified to OFF
MOMENTARY (Output name or #)	Turns the Output specified to MOMENTARY
Z-WAVE HELP	List of Z-Wave compatible text commands
STAUS LIGHTS	To receive a status update for all light devices
TURN ON (Light name)	Turns the specified light to ON
TURN ON (Light name) (Dimmer level)	Turns dimmer light on to a specific temp
TURN OFF (Light name)	Turns the specified light to OFF
STATUS LOCKS	To receive a status update for all lock devices
LOCK (Lock name)	Locks the specified door lock
UNLOCK (Lock name)	Unlocks the specified door lock
STATUS THERMOSTAT	To receive a status update for the thermostat
SET (thermometer name) COOL (Temp)	Set thermostat to Cool with specific temp
SET (thermometer name) HEAT (Temp)	Set thermostat to Heat with specific temp
SET (therm name) AUTO (Hi & Lo Temp)	Set thermostat to Auto with specific temps
ACTIVATE (Favorite name)	Activate the devices in the Favorite

Z-Wave Device Names:

Device #	Z-Wave Device Name

Cut along dotted lines.

1. Call the panel phone number. The panel answers and sounds one short tone.
2. Enter your code within eight seconds. One beep means the code is good. Four short beeps means enter it again. You have three tries.
3. You have 30 seconds to enter the first command (see other side) and 30 seconds for each additional command.

If	You will hear
All areas are armed	3 short beeps
Area 1 (Perimeter) is armed	1 short beep
Any area is armed	2 short beeps
All areas are disarmed	1 long beep

Text	For this action
OFF (Output name or #)	Turns the Output specified to OFF
MOMENTARY (Output name or #)	Turns the Output specified to MOMENTARY
Z-WAVE HELP	List of Z-Wave compatible text commands
STAUS LIGHTS	To receive a status update for all light devices
TURN ON (Light name)	Turns the specified light to ON
TURN ON (Light name) (Dimmer level)	Turns dimmer light on to a specific temp
TURN OFF (Light name)	Turns the specified light to OFF
STATUS LOCKS	To receive a status update for all lock devices
LOCK (Lock name)	Locks the specified door lock
UNLOCK (Lock name)	Unlocks the specified door lock
STATUS THERMOSTAT	To receive a status update for the thermostat
SET (thermometer name) COOL (Temp)	Set thermostat to Cool with specific temp
SET (thermometer name) HEAT (Temp)	Set thermostat to Heat with specific temp
SET (therm name) AUTO (Hi & Lo Temp)	Set thermostat to Auto with specific temps
ACTIVATE (Favorite name)	Activate the devices in the Favorite

Cut along dotted lines.

This page intentionally left blank.



Digital Monitoring Products



LT-0982 1.04



12115

